

PanelView Component HMI Terminals

Catalog Numbers 2711C-F2M, 2711C-K2M, 2711C-T3M, 2711C-K3M, 2711C-T4T, 2711C-T6M, 2711C-T6C, 2711C-T6T, 2711C - T10C



Important User Information

Solid state equipment has operational characteristics differing from those of electromechanical equipment. Safety Guidelines for the Application, Installation and Maintenance of Solid State Controls (publication [SGI-1.1](#) available from your local Rockwell Automation sales office or online at <http://www.rockwellautomation.com/literature/>) describes some important differences between solid state equipment and hard-wired electromechanical devices. Because of this difference, and also because of the wide variety of uses for solid state equipment, all persons responsible for applying this equipment must satisfy themselves that each intended application of this equipment is acceptable.





In no event will Rockwell Automation, Inc. be responsible or liable for indirect or consequential damages resulting from the use or application of this equipment.

The examples and diagrams in this manual are included solely for illustrative purposes. Because of the many variables and requirements associated with any particular installation, Rockwell Automation, Inc. cannot assume responsibility or liability for actual use based on the examples and diagrams.

No patent liability is assumed by Rockwell Automation, Inc. with respect to use of information, circuits, equipment, or software described in this manual.

Reproduction of the contents of this manual, in whole or in part, without written permission of Rockwell Automation, Inc., is prohibited.

Throughout this manual, when necessary, we use notes to make you aware of safety considerations.

	WARNING: Identifies information about practices or circumstances that can cause an explosion in a hazardous environment, which may lead to personal injury or death, property damage, or economic loss.
	ATTENTION: Identifies information about practices or circumstances that can lead to personal injury or death, property damage, or economic loss. Attentions help you identify a hazard, avoid a hazard, and recognize the consequence
	WARNING: Labels may be on or inside the equipment, for example, a drive or motor, to alert people that dangerous voltage may be present.
	WARNING: Labels may be on or inside the equipment, for example, a drive or motor, to alert people that surfaces may reach dangerous temperatures.
IMPORTANT	Identifies information that is critical for successful application and understanding of the product.

■ Rockwell Automation, Allen-Bradley, PanelView, PanelView Component, Connected Components Workstation, and TechConnect are trademarks of Rockwell Automation, Inc.

Trademarks not belonging to Rockwell Automation are property of their respective companies.

Summary of Changes

The information below summarizes the changes to this manual since the last publication.

To help you find new and updated information in this release of the manual, we included change bars as shown to the right of this paragraph.

Topic	Section
Intended Audience	9
Supported Browsers and Platforms	18
About PanelView Component DesignStation 2.0	119
About PanelView Component DesignStation 3.0	120
Install the Software	121
Uninstall the Software	125

Notes:

Summary of Changes

Table of Contents

Preface

Objectives 9
 Intended Audience 9
 Additional Resources 9
 Firmware Upgrades..... 10

Overview

Chapter 1

Chapter Objectives 11
 About the Terminals 11
 How to Connect Browser..... 13
 PanelView Explorer..... 14
 How to Display Help..... 14
 Peripheral Connection..... 15
 Catalog Number Configuration 16

Configuration Mode

Chapter 2

Chapter Objectives 17
 Configuration Mode 17
 Configuration Interfaces..... 20
 Terminal Settings 22
 Managing Applications and Files 49
 Transferring Applications..... 50
 Validate the Application 52
 Transferring User-defined Objects..... 53

**Install and Replace
 Components**

Chapter 3

Chapter Objectives 55
 SD Memory Card 55
 USB Flash Drive 55
 Battery Replacement..... 56

**Cable Connections and
 Communication**

Chapter 4

Chapter Objectives 59
 Wiring and Safety Guidelines..... 59
 Connecting Devices 60
 MicroLogix Controller Cable Charts 60
 Ethernet Connection 61
 Serial Connections 63
 USB Ports 64

Upgrade Firmware

Chapter 5

Chapter Objectives 75
 Prepare for Firmware Upgrade..... 75

	Firmware Installation Using Removable Storage Device	76
Troubleshoot the System	Chapter 6	
	Chapter Objectives	81
	View System Information	81
	Alerts	81
	Troubleshooting	90
	Returning to the Out-of-box Condition	92
Specifications	Appendix A	
	General Specifications	95
	Environmental	97
	Certifications	97
Adding Font Files	Appendix B	
	Available Fonts	99
	Set up Fonts for PanelView Component DesignStation 2.0	99
	Import a Font File	99
	Remove a Font File	100
PanelView Component Emulator	Appendix C	
	Overview	103
	Install the Emulator	103
	Uninstall the Emulator	110
	Directory Layout and Content	112
	Launch Mechanism	114
	Using the Emulator	115
	Error Codes	117
PanelView Component DesignStation	Appendix D	
	Overview	119
	About PanelView Component DesignStation 2.0	119
	About PanelView Component DesignStation 3.0	120
	Install the Software	121
	Uninstall the Software	125
	Directory Layout and Content	126
	Launch Mechanism	126
	Using PanelView Component DesignStation	127
Firmware Update Utility	Appendix E	
	Chapter Objectives	129
	About the Utility	129
	Install the Utility	131

Update Firmware..... 132
Clean File System or Clean Registry..... 135
Resolve Firmware Upgrade Issues..... 137
Software Maintenance 140

Index

Notes:

Objectives

This preface provides information on these topics.

- Intended audience
- Additional resources
- Firmware upgrades

Intended Audience

Use this manual if you are responsible for operating, or troubleshooting the PanelView Component terminals. This manual provides information for configuring the PanelView Component terminal. You can configure the terminal on the terminal, through a web browser on a computer connected to the terminal.

This manual does not give procedures for creating applications that run on the terminal.

No special knowledge is required to understand this manual or operate the terminal.

Equipment installers must be familiar with standard panel installation techniques.

Additional Resources

For additional information on the PanelView Component terminals, refer to these publications, that you can download from <http://literature.rockwellautomation.com>.

Resource	Description
PanelView Component Terminal Installation Instructions, publication 2711C-IN001	Provides instructions for installing a PanelView Component terminal.
PanelView Component Operator Terminals Quick Start, publication 2711C-QS001	Provides instructions on setting up a sample application on a PanelView Component terminal.

If you would like a manual, you can:

- download a free electronic version from the Internet at <http://literature.rockwellautomation.com>
- purchase a printed manual by contacting your local Allen-Bradley distributor or Rockwell Automation sales office.

Firmware Upgrades

To receive firmware upgrades and other downloads for your PanelView Component terminal:

- call your local Rockwell Automation sales office or distributor.
- access <http://ab.rockwellautomation.com/Graphic-Terminals/2711C-PanelView-Component-Terminals>

Overview

Chapter Objectives

This chapter gives an overview of the PanelView component terminals.

- About the terminals
- How to connect browser
- PanelView Explorer
- How to display help
- Peripheral connection
- Catalog number configuration

About the Terminals

PanelView Component terminals are operator interface devices for monitoring and controlling devices attached to a controller. HMI applications are created using a Web application while your computer is connected directly to the terminal. You see the direct result on the terminal display without having to download first.

PanelView Component C200 and C300 Terminals

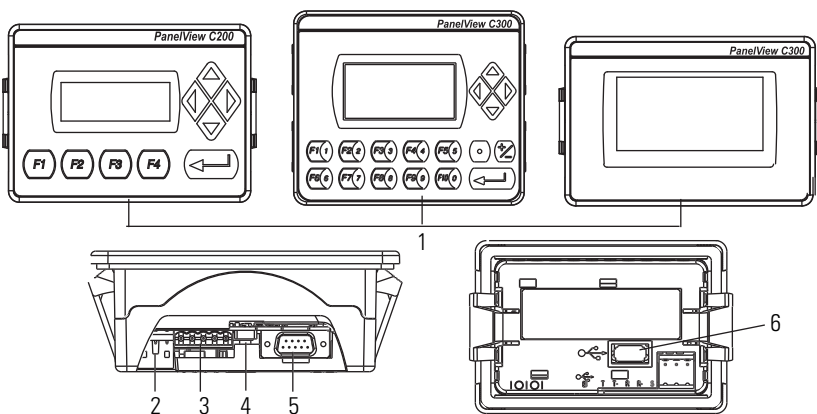

Item	Description	Item	Description
1	Function keys, keypad, or touch display	4	USB device port
2	24V DC power input	5	RS-232 serial port
3	RS-422 and RS-485 port	6	USB host port

PanelView Component C400 Terminals

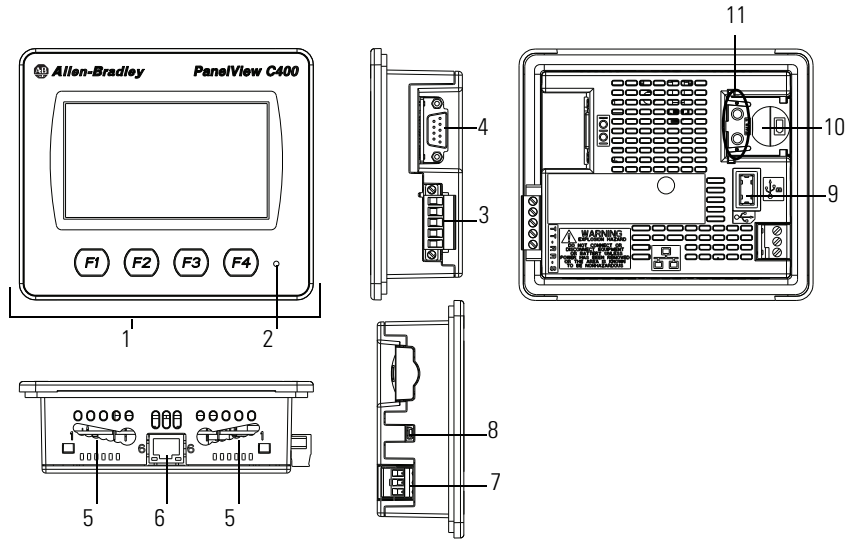

(C400 Series A terminal shown)

Item	Description	Item	Description
1	Touch, function keys display	6	Mounting slots
2	Power status indicator	7	RS-232 serial port
3	24V DC power input	8	USB host port
4	10/100 MBit Ethernet port	9	Diagnostic status indicator
5	RS-422 or RS-485 port	10	Replaceable real-time clock battery

PanelView Component C600 and C1000 Terminals

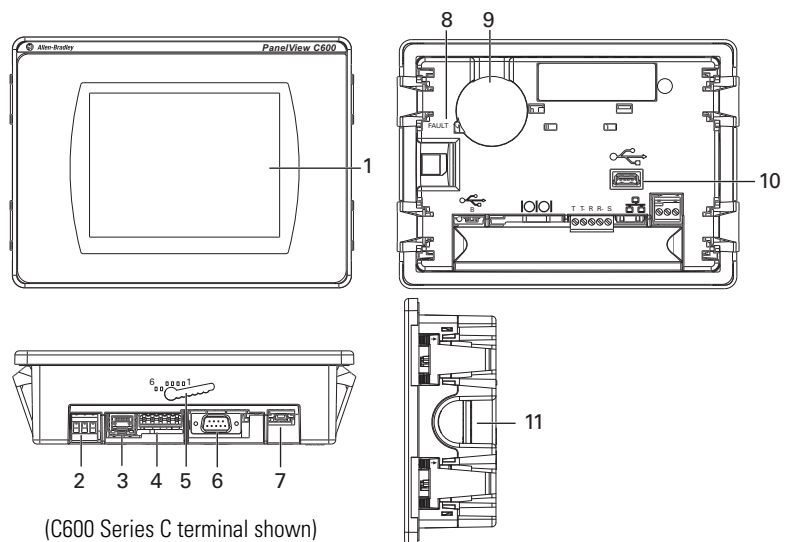

(C600 Series C terminal shown)

Item	Description	Item	Description
1	Touch display	6	RS-232 serial port
2	24V DC power input	7	USB device port
3	10/100 MBit Ethernet port	8	Diagnostic status indicator
4	RS-422 or RS-485 port	9	Replaceable real-time clock battery
5	Mounting slots (for 2711C-T6M, -T6C Series C or later, 2711C-T6T Series A or later only)	10	USB host port
		11	Secure digital (SD) card slot

IMPORTANT Analog touch screens are intended for single presses at a time. If the touch screen is pressed in two locations at the same time, the presses are averaged as a single press in-between the two locations.

How to Connect Browser

The terminals can be connected to a browser using either a USB port or an Ethernet network connection. Your computer should have at least an Intel Pentium M 1400 MHz processor, with 512 MB RAM.

You must enter the IP address of the PanelView Component terminal into the address field of your browser. You can find the IP address on the terminal configuration screen under Communications.

USB Port

The PanelView Component terminals have a USB device port to support communication with the terminal using TCP/IP.

IMPORTANT Before connecting your computer to the USB port of the PanelView Component terminal, you must first install the Allen-Bradley PanelView USB remote NDIS Network Device driver on your computer. [Refer to Install the USB Driver on page 65.](#)

With the USB device port connected to a computer, use your computer's browser to connect to the terminal. The IP address of the USB port is always 169.254.254.2.

IMPORTANT The USB device port is for maintenance or programming only, and is not intended for normal run-time operation.

Ethernet Port

The C400, C600 and C1000 terminals have an Ethernet port. The Ethernet port supports both static IP addresses and Dynamic Host Configuration Protocol (DHCP) assigned IP addresses. If using static IP addressing, then you manually set the IP address, the subnet mask, and the default gateway. If using DHCP, then the server automatically assigns an IP address, the subnet mask, the default gateway, and the DNS and WINS server.

IMPORTANT If a terminal is set for DHCP and is not on a network or is on a network that does not have a DHCP server (or the server is not available), it will automatically assign itself an Automatic Private IP Address (or auto IP address). The auto IP address will be in the range of 169.254.0.0 through 169.254.255.255.

The terminal makes sure the auto IP address is unique from any other auto IP address of other devices on the network. The terminal can now communicate with other devices on the network that have IP addresses in the 169.254.xxx.xxx range (and a subnet mask of 255.255.0.0).

PanelView Explorer

PanelView Explorer is the design environment for the PanelView Component terminals. You access the design environment through your browser while connected to the terminal. Applications created in the design environment are simultaneously viewed on the connected terminal. In addition to graphic objects and drawings, the design environment provides support for communication, tags, alarms, security, recipes, and language support.

How to Display Help

PanelView Explorer software provides extensive help for the design environment. Context-sensitive help is available for:

- each navigation tab.
- each object in the object palette.
- any dialog that has a Help button.

Click the ? on the application toolbar to view the help.

No Help Files Found

To view help information in your browser, you must download the help files from the PanelView Component web site, copy them to external media, and then insert the media in the terminal. External media can be a USB flash drive or an SD memory card.

Terminal Users

Copy the help files to the WebHelp folder off the root directory of the SD memory card or USB flash drive into a folder named \WebHelp.

Emulator Users

Copy the help files to the WebHelp folder in the shared directory of the emulator, for example, C:\Documents and Settings\All Users\Shared Documents\Allen-Bradley\PanelView Component Emulator\WebHelp.

View Help Files

After copying the help files to external media and inserting the media in the terminal, you can view the help files by closing this help window and clicking the help ? button again.

TIP When receiving updated help files, you may have to clear cache in your browser before the new help files display.

View the PanelView Explorer online Help for detailed instructions.

Peripheral Connection

PanelView Component terminals have a USB host port. You can power USB peripherals directly from the PanelView Component terminal. If the USB peripheral is not powered directly from the PanelView USB port either:

- install the USB peripheral in the same enclosure as the PanelView terminal and make sure it is connected to the same ground system.
- connect to the USB peripheral through a galvanically isolated hub.



ATTENTION: Removing the USB flash drive or SD card, from the PanelView Component terminal, while a firmware upgrade is in process, could corrupt the firmware and make the terminal unusable. Take precautions to prevent the USB flash drive or SD card from being accidentally disconnected. Also, do not power off the terminal while a firmware upgrade is in progress.

ATTENTION: USB hubs can produce unexpected behaviors and as a result are not recommended.

Catalog Number Configuration

These are the available PanelView Component terminals.

Cat. No.	Model	Operator Input	Size	Display Type
2711C-F2M	C200	Function keys	2 in.	Monochrome
2711C-K2M		Numeric and function keys		
2711C-T3M	C300	Touch screen	3 in.	
2711C-K3M		Numeric and function keys		
2711C-T6M	C600	Touch screen	6 in.	Monochrome
2711C-T6C				Color STN
2711C-T6T				Color TFT
2711C-T10C	C1000	Touch screen	10 in.	Color STN
2711C-T4T	C400	Touch screen and function keys	4 in.	Color TFT

Configuration Mode

Chapter Objectives

This chapter covers topics that show how to use the Configuration mode of your PanelView component terminal.

- Configuration mode
- Configuration interfaces
- Terminal settings
- Managing applications and files
- Transferring applications
- Transferring user-defined objects

Configuration Mode

The terminal can be configured from either the design time or the runtime user interface. The design-time user interface requires a computer browser connected to the terminal's web service, where the runtime user interface uses configuration screens on the terminal. The configuration data for a terminal refers to the collection of all of the system interface parameters.

Access to the Terminal's Configuration

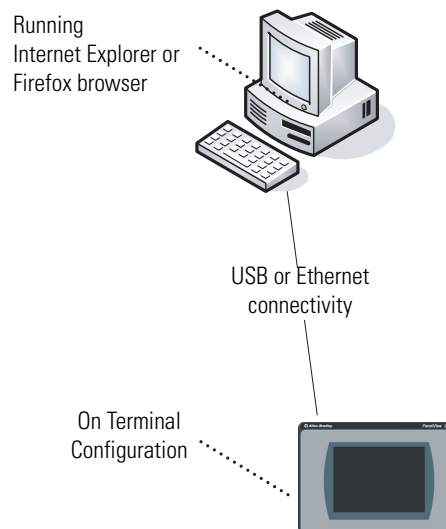

Design-time Configuration

The design-time configuration is when the terminal is actually hosting web server content that represents a visualization of the terminal's properties and files. You can only design for the terminal type that you are connected to.

When a new application is created, the design time automatically navigates to the first screen and assigns it as the startup screen.

The design-time environment is compatible with these operating systems:

- Windows 2000 (catalog numbers 2711C-T4T, 2711C-T6M, 2711C-T6C, 2711C-T6T, and 2711C-T10C only, using an Ethernet connection to connect to the terminal)
- Windows XP
- Windows Vista
- Windows 7

TIP Connecting to a terminal using a USB connection is not compatible with Windows 2000 operating system.

The PanelView Component Emulator is not compatible with Windows 2000 operating system.

A user application can be created or edited through a browser connected to a terminal or emulator, or through PVc DesignStation. Ethernet network and USB connections are supported for connection to a physical terminal. For the emulator, the emulator and browser must be on the same computer.

Supported Browsers and Platforms

Operating System	Browser	Platform Supported
Windows Vista (32 bit only) Windows XP SP3 (32 bit only)	Internet Explorer 7/8, Firefox 3.0	Terminal and emulator
Windows 7	Internet Explorer 7/8	PVc DesignStation 2.0
Windows Vista Windows XP SP3	—	PVc DesignStation 3.0

If you use a browser other than a recommended browser, this message appears.

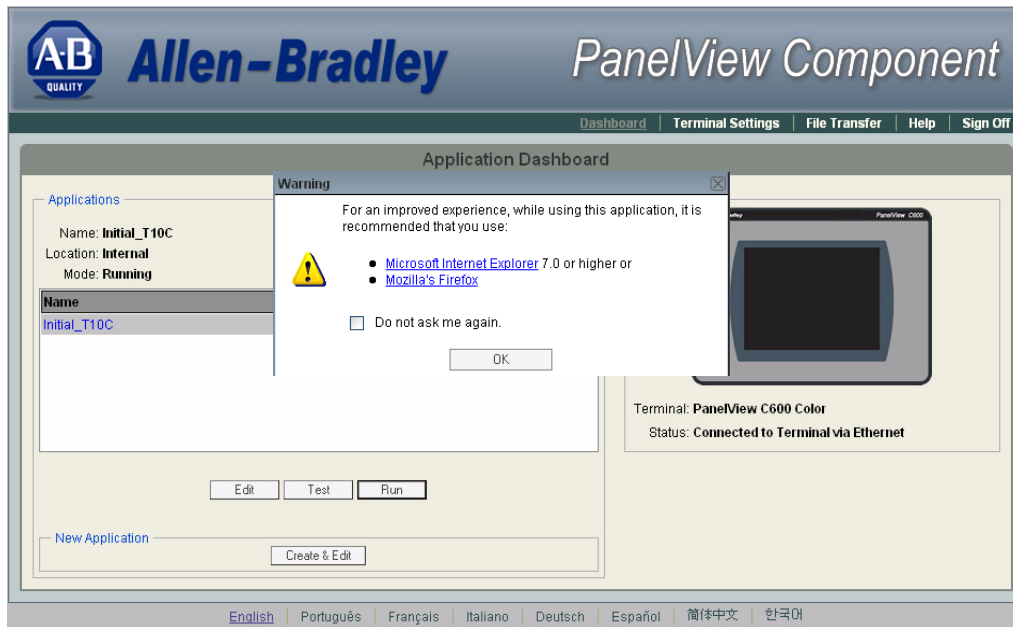

Runtime Configuration

The runtime configuration is when you make changes on the actual terminal. Changes can be made whether an application is running or not running.

C200



C300

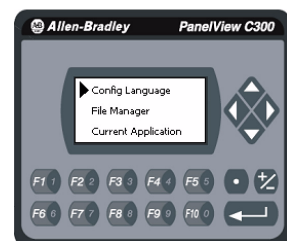

C400, C600 and C1000

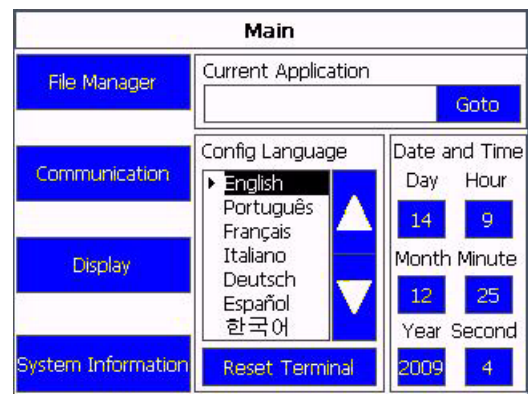

Configuration Interfaces

Terminal settings can be configured either on the terminal or through a web browser using the PanelView Explorer Startup window.

Terminal Interface

The on-terminal interface lets you make changes to the terminal configuration. On the C200 and C300 terminals, you have to use the arrows to scroll through the menu. The C400, C600, and C1000 terminals have the menu displayed on the left side of the terminal screen.

C200 - Function Keys



C300 - Touch Screen



C400, C600, C1000 - Touch Screen

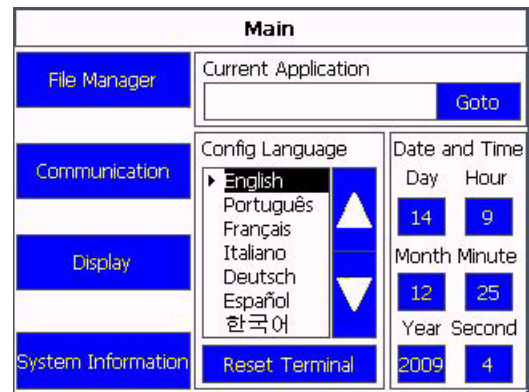

C200 - Function and Numeric Keys

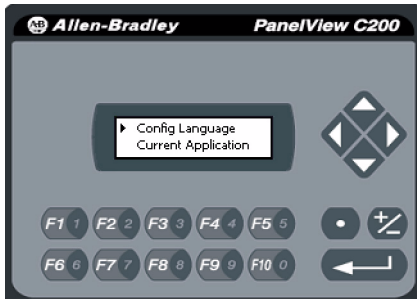

C300 - Function and Numeric Keys

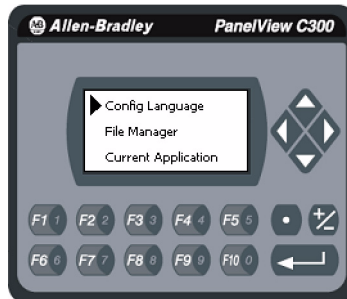

PanelView Explorer Startup Window

The PanelView Explorer Startup window lets you access the terminal through a web browser.

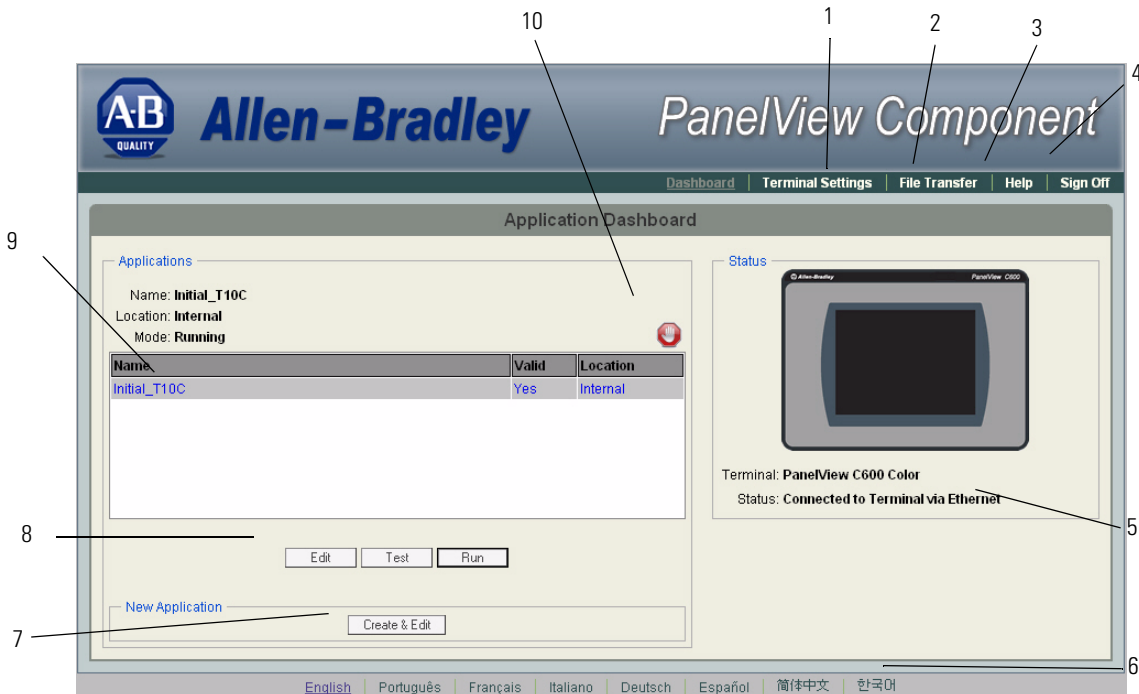

PanelView Explorer Startup Window

Item	Function	Description
1	Terminal Settings	Use this link to view and change terminal display and communication settings, view system information, and enable terminal security while connected to the terminal.
2	File Transfer	Transfers files between the storage media of the terminal and your computer. You can transfer applications, images, fonts, user-defined objects, screen saver bitmaps and recipes. You can also delete applications from terminal storage and export the alarm history log.
3	Help	Displays help for the PanelView Explorer startup window and the design-time software.
4	Sign off	Logs you off the Startup window leaving your browser open.
5	Terminal Type and Status	Shows the current connection between your PanelView Component terminal and computer and the type of terminal.
6	Language	Shows the current and available languages for the design-time software.
7	Create New Application	Opens a new application in the design-time environment window.
8	Edit, Test, Run	Use these buttons to edit, test, and run the currently loaded application.
9	Available Applications	Shows a list of applications stored on the terminal, USB memory, SD card, or PC Storage on the emulator. The list also shows if the file has been validated for correct operation.
10	Stop	Click the Stop button (the stop sign shown when an app is loaded and in Edit/Test/Run mode) to unload the currently loaded application. If you have not saved changes to the application, you are prompted to do so. Once the application is unloaded, the terminal displays the Configuration screen.

Terminal Settings

Terminal settings can be set on the terminal or through the PanelView Explorer Startup window.

Adjusting Settings on the Terminal

From the terminal, you can view and edit the terminal settings. The settings take effect immediately.

By clicking the menu items on the screen you can:

- switch to the currently running application.
- configure the terminal language.
- change the current application.
- adjust the display brightness and contrast.
- configure screen saver settings.
- calibrate the touch screen, if supported.
- reboot or reset the terminal.
- view system information.
- change the startup application.
- change the current date and time.
- set Ethernet network communication.

Terminal Main Menu

C200



C300

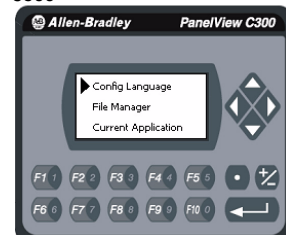

C400, C600 and C1000

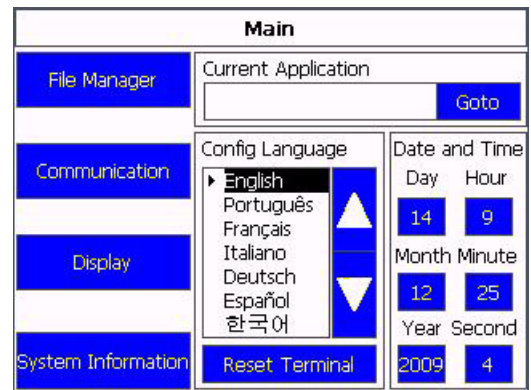

These settings can also be changed using the PanelView Explorer Startup Window.

Adjusting Settings on the PanelView Explorer Startup Window

From the PanelView Explorer Startup window, you can view and edit settings for the connected PanelView Component terminal. The settings take effect immediately.

By clicking the Terminal Settings link on the PanelView Explorer Startup window, you can access tabs to:

- adjust the display brightness and contrast.
- configure screen saver settings.
- configure key repeat settings.
- calibrate the touch screen (if supported).
- reset the terminal.
- view system information.
- change the startup application.
- change the terminal language.
- change the current date and time.
- Ethernet communication.
- change the password of the system administrator.

Most of these settings are also adjusted from configuration mode on the terminal.

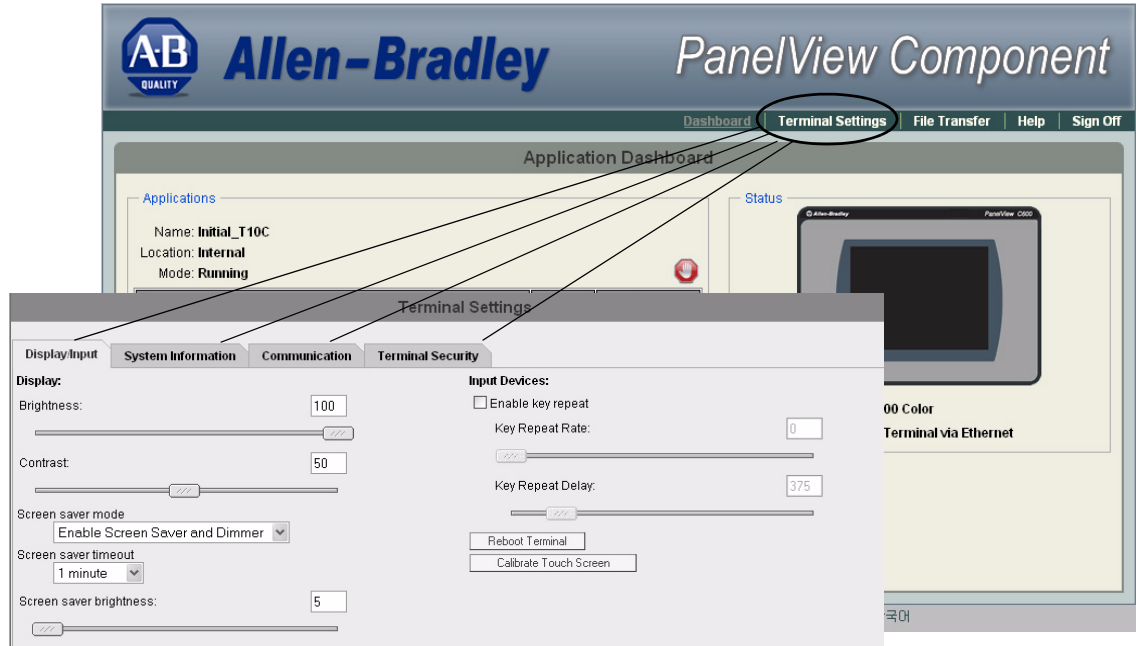

Select a Terminal Language

You can change the terminal display language. The terminal is shipped with the English, Portuguese, French, Italian, German, Spanish, and Chinese fonts installed. Korean is available but you must first install the Korean font. Refer to page 76 for information on how to install the font by upgrading the firmware.

Follow these steps to change the terminal language using the PanelView Explorer Startup window.

1. Go to the PanelView Explorer Startup window.
2. Click the Terminal Settings link.
3. Click the System Information tab.
4. Select a language from the Terminal Language pull-down list.

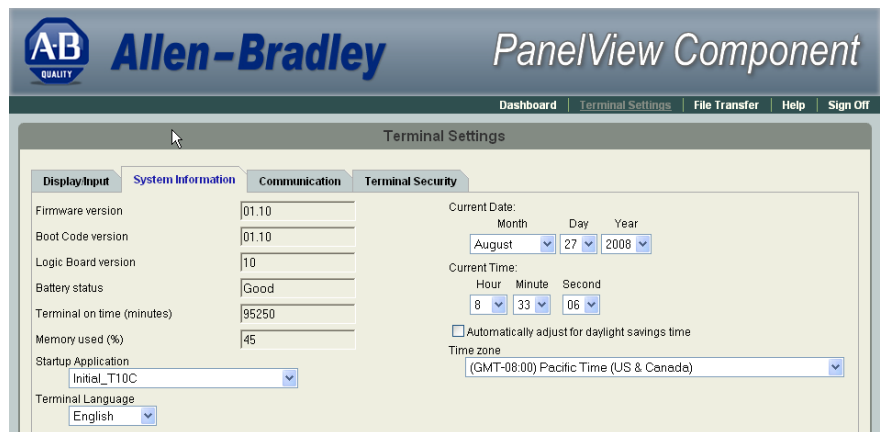

5. Click Apply or click Cancel to restore the current setting.

On the C400, C600 and C1000 terminals the default language is set on the Main menu. Just click the up and down arrows to select the language.

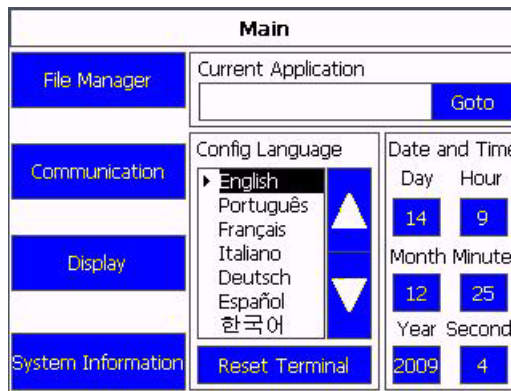

Follow these steps to change the language on the C200 and C300 terminals.

1. Click Config Language.

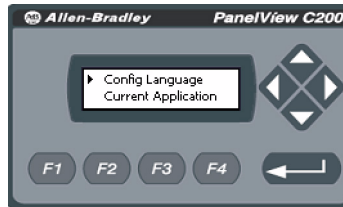

2. Press F1 to select the language.

The display changes to the language you select immediately.



IMPORTANT At runtime, diagnostic messages appear in the same language as the application if the application language is English, Portuguese, French, Italian, German, Spanish, Chinese, or Korean. For all other languages, the diagnostic messages appear in the configuration language set on the terminal.

Adjust the Display Brightness and Contrast

You can modify the brightness and contrast of the terminal display. You can use the default intensity of 50% for contrast and 100% for brightness or adjust the intensity for runtime operations.

TIP On the C400 (2711C-T4T), C600 (2711C-T6T) and C1000 terminals, only the brightness can be changed.

Follow these steps to change the display brightness and contrast using the PanelView Explorer Startup window.

1. Go to the PanelView Explorer Startup window.
2. Click the Terminal Settings link.
3. Click the Display/Input tab.
4. Drag the slider to adjust the brightness level between 1...100%.
5. Drag the slider to adjust the contrast level between 1...100%.
6. Click Apply, or click Cancel to restore the current terminal settings.

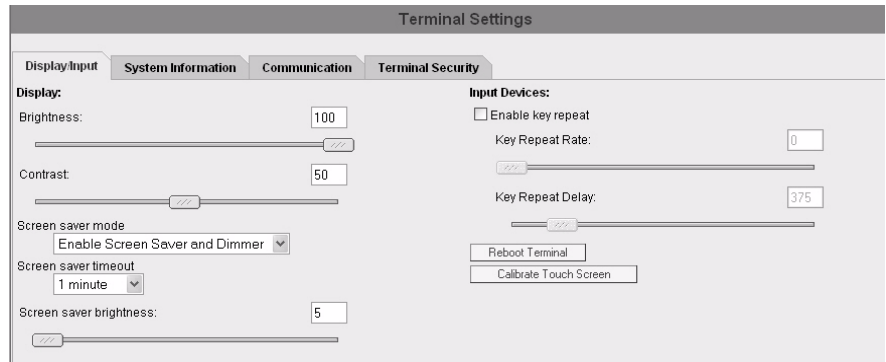

Follow these steps to change the display brightness or contrast from the terminal.

1. Click Display on the menu list.

C200, C300

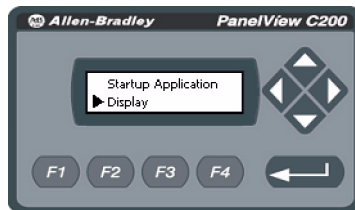

C400, C600, C1000

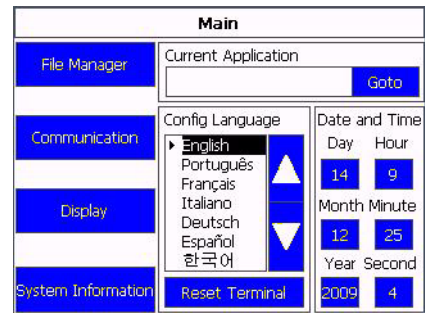

2. Use the arrow keys to adjust the brightness or contrast up or down.

On the C200 and C300 terminals, press F3 to go to the contrast adjustment screen. The change takes effect immediately.

TIP The C400 (2711C-T4T), C600 (2711C-T6T) and C1000 have only a brightness control.

C200, C300 Brightness



C200, C300 Contrast

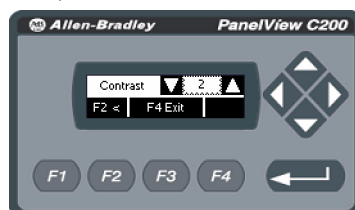

C400 and C600 Brightness and Contrast

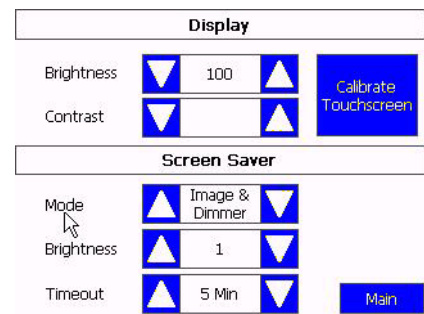

Configure the Screen Saver

You can enable or disable the screen saver on the connected PanelView Component terminal.

The terminal has four screen saver modes: screen saver, dimmer, screen saver and dimmer, or disable.

- Screen saver – activates after the idle timeout elapses using a default screen saver image. The screen saver deactivates when you press a key.
- Dimmer – dims the display from full brightness to the brightness level you set when the idle timeout elapses. While the display is dimmed, you can still see on-screen activity. When you press a key, the display is restored to full brightness.
- Screen saver and dimmer – activates the screen saver and dims the display when the idle timeout elapses.
- Disable screen saver and dimmer – keeps the display on.

The screen saver timeout is the amount of idle time that must elapse before the screen saver, dimmer, or screen saver and dimmer activates. The idle time can be adjusted between 1...60 minutes.

The brightness intensity of the screen saver or dimmer can be adjusted between 1...100%.

Follow these steps to configure the screen saver using the PanelView Explorer Startup window.

1. Go to the PanelView Explorer Startup window.
2. Click the Terminal Settings link.
3. Click the Display/Input tab.
4. Select a screen saver mode from the list.

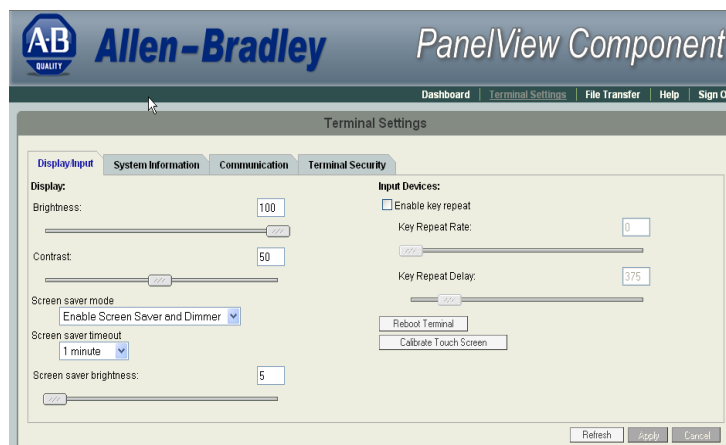

5. Select a time from the pull-down list to adjust the screen saver timeout.

6. Drag the slider to adjust the screen saver brightness.
7. Click Apply, or click Cancel to restore the current screen saver settings.

To disable the screen saver or dimmers, select Disable Screen Saver and Dimmer from the screen saver mode list.

Follow these steps to configure the screen saver from the C400, C600 and C1000 terminals.

1. Click Display on the menu list.
2. Select the Mode.
Mode = Image, Disable, Dimmer, Image and Dimmer.
3. Select the brightness.
Brightness 1...100, increments of 1.
4. Select the idle time.
Choices are 1, 2, 5, 10, 15, 20, 30, or 60 min.

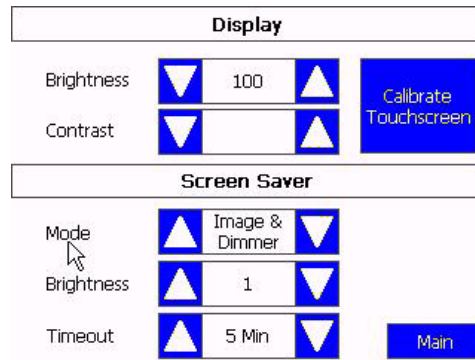

Follow these steps to configure the screen saver from the C200 and C300 terminals.

1. Select Screen Saver on the menu list and press the enter key.

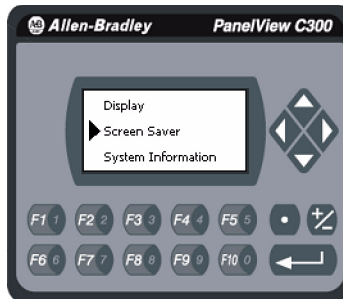

2. Press F1 to select the Mode.

Mode = Image, Disable, Dimmer, Image and Dimmer.

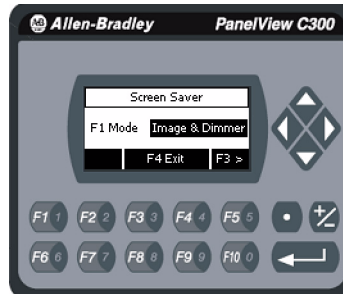

3. Press F3 and use the arrows to select the brightness.
Brightness 1...100, increments of 1.

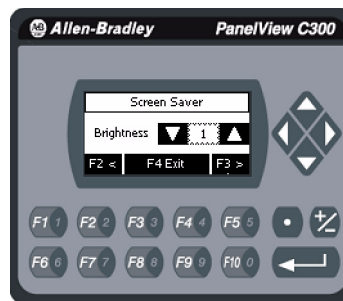

4. Press F3 to get to the Timeout selection.

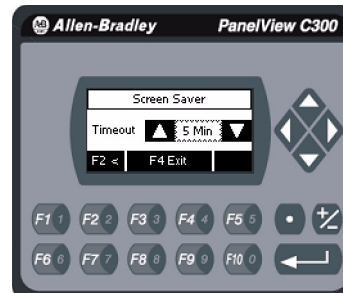

5. Press F1 to select the time.
Choices are 1, 2, 5, 10, 15, 20, 30, or 60 min.

Replace the Screen Saver Image

The default screen saver image is a floating Allen-Bradley logo in a bitmap format. The name of the default screen saver is 'Screen Saver' with a .bmp file type. You can replace the default screen saver with your own bitmap image, but the file must have the same name as the default screen saver.

To replace the screen saver image:

1. Create a small bitmap image no larger than 128 x 128 pixels.

2. Save your bitmap file to your computer, a USB drive or and SD card. Rename your file as 'Screen Saver' and make sure the file type is .bmp.
3. Click the File Transfer link in the PanelView Explorer Startup window, then click New Transfer.
4. Select either My Computer or USB/SD Storage as file source depending on where you saved your file, then click Next.
5. Select Screen Saver Image as the file type, then click Next.
6. Locate where you saved your bitmap file on your computer or external storage device.
7. Select Internal Storage as file destination, then click Transfer. The bitmap file is successfully transferred to the PVC terminal.

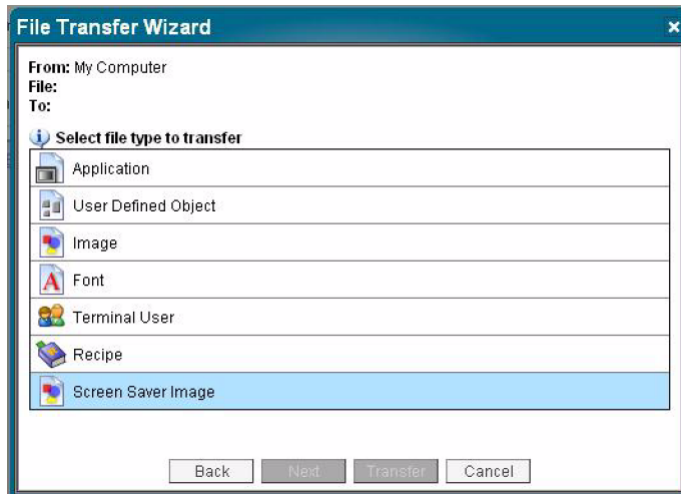

The new screen saver takes affect the next time the screen saver is activated.

TIP Your bitmap file should be small in size. A large bitmap will impact performance of terminal operations.

Configure Key Repeat Settings

You can configure key repeat settings for the terminal keys or attached keyboard of the connected terminal.

TIP You cannot change the key repeat settings from the on-terminal configuration screens. If you want to change this setting, you must connect to the terminal through a web browser.

The repeat rate is the speed at which a character repeats per second when you hold down a key. The repeat delay is the amount of time, in milliseconds, that elapses before a character begins to repeat when you hold down a key.

Follow these steps to change the repeat settings for keys.

1. Go to the PanelView Explorer Startup window.
2. Click the Terminal Settings link.
3. Click the Display/Input tab.
4. Check Enable key repeat to enable repeat settings for keys.

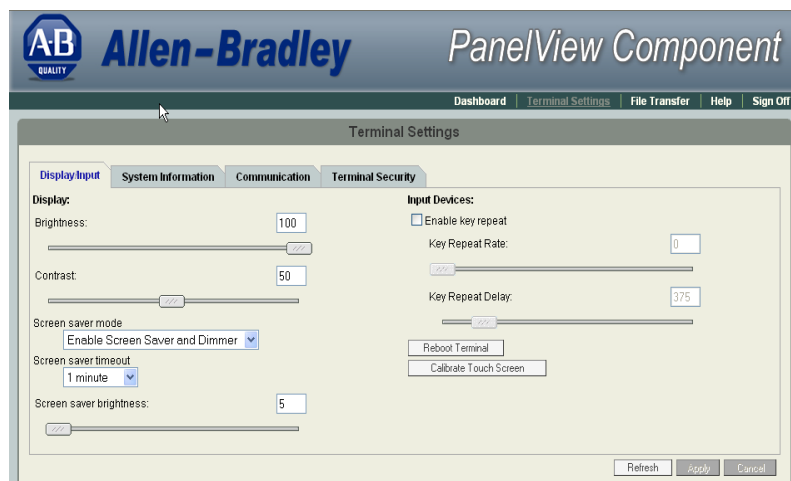

5. Drag the slider under Key Repeat Rate to adjust the speed at which a character repeats when a key is held down.
6. Drag the slider under Key Repeat Delay to set the amount of time that elapses before a character begins to repeat when the key is held down.
7. Click Apply or click Cancel to restore the current settings.

To disable key repeat settings, uncheck Enable key repeat.

Calibrate the Touch Screen

Over time you may notice that the objects and images on the display screen don't seem to fit the display area as well as they once did. This is normal with a touch screen and can be easily fixed.

Use a plastic stylus device with a minimum tip radius of 1 mm (0.040 in.) to prevent damage to the touch screen.

IMPORTANT Touch screen calibration is only supported on touch only terminals, catalog numbers 2711C-T3M, 2711C-T4T, 2711C-T6C, 2711C-T6T, 2711-T6M, and 2711-T10C.

Follow these steps to calibrate the touch screen using the PanelView Explorer Startup window.

1. Go to the PanelView Explorer Startup window.
2. Click the Terminal Settings link.
3. Click the Display/Input tab.
4. Click Calibrate Touch Screen.

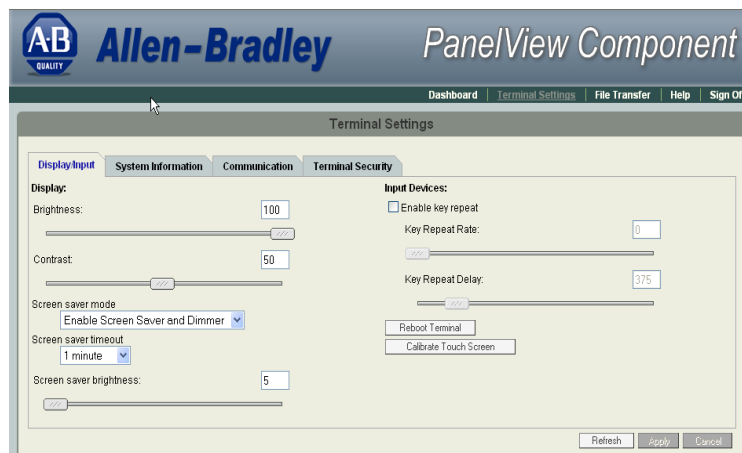

5. With a stylus, press the center of the target (+) on the screen.



6. Repeat step 5 as the target moves around the screen.
7. Tap the screen when prompted to register saved data.

If you don't tap the screen within 30 seconds, the calibration data is lost and the current settings are retained.

Follow these steps to calibrate the touch screen from the terminal.

1. Click Display on the menu list.
2. For C400, C600 and C1000 terminals, click Calibrate Touchscreen.

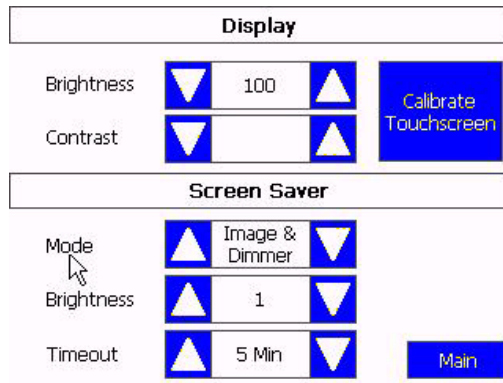

3. For C300 touch screen terminals, press the right arrow to go to the calibration screen.



4. Carefully press and briefly hold stylus on the center of the target. Repeat as the target moves around the screen.

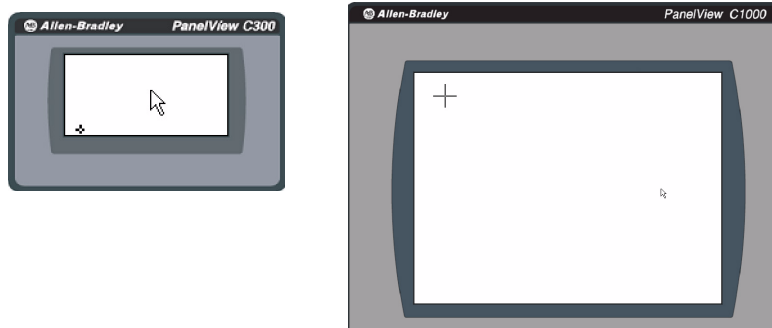

5. Click OK within 30 seconds once the message appears to accept the changes or the old settings are kept.



Reboot the Terminal

You can restart the terminal without having to disconnect and reapply power. After a reset, the terminal performs a series of startup tests and then either enters configuration mode or runs the startup application.

Follow these steps to reboot the terminal from the PanelView Explorer Startup window.

1. Go to the PanelView Explorer Startup window.
2. Click the Terminal Settings link.
3. Click the Display/Input tab.
4. Click Reboot Terminal button.

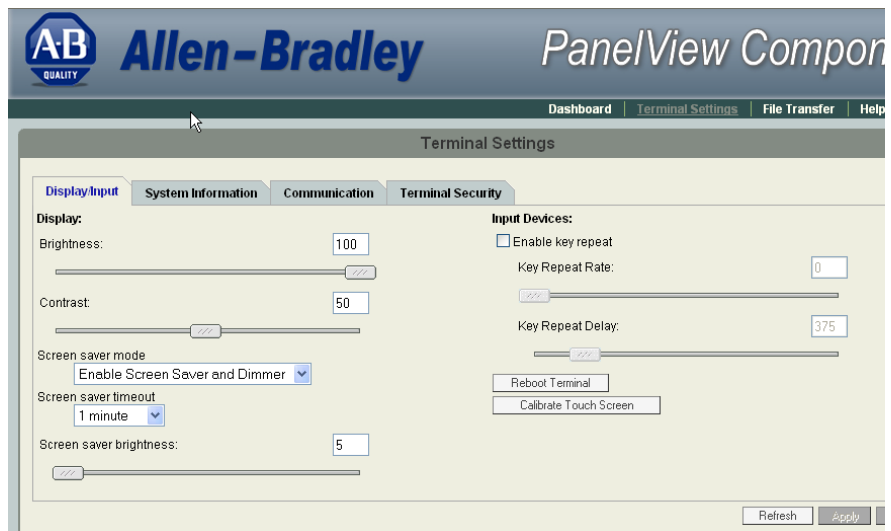

Follow these steps to reboot the terminal from the C400, C600 and C1000 terminals.

1. Go to the Main configuration screen.
2. Press Reset Terminal.

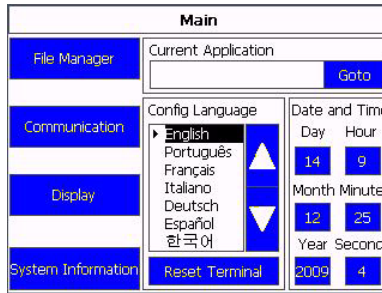

3. Confirm reset.

Follow these steps to reboot the terminal from the C200 and C300 terminals.

1. Select Reset Terminal from the menu list.

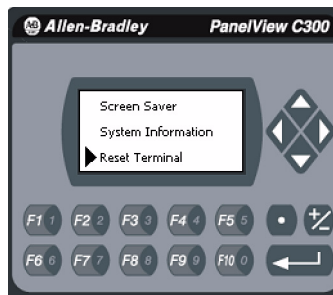

2. Press F1 to reset the terminal.

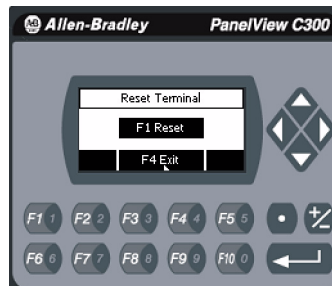

3. Confirm restart.

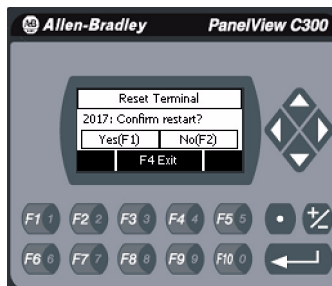

Change the Startup Application

You can select or change the application that runs on the terminal each time the terminal starts up. You must also select the storage location of the application. The options are internal storage of the terminal, USB flash drive, SD card, or PC storage.

IMPORTANT If the application list is empty, the run, copy, delete, and set as startup functions will not perform any action.

Follow these steps to select or change the startup application using the PanelView Explorer Startup window.

1. Go to the PanelView Explorer Startup window.
2. Click the Terminal Settings link.
3. Click the System Information tab.
4. Select the name of the startup application from the Startup Application pull-down list.

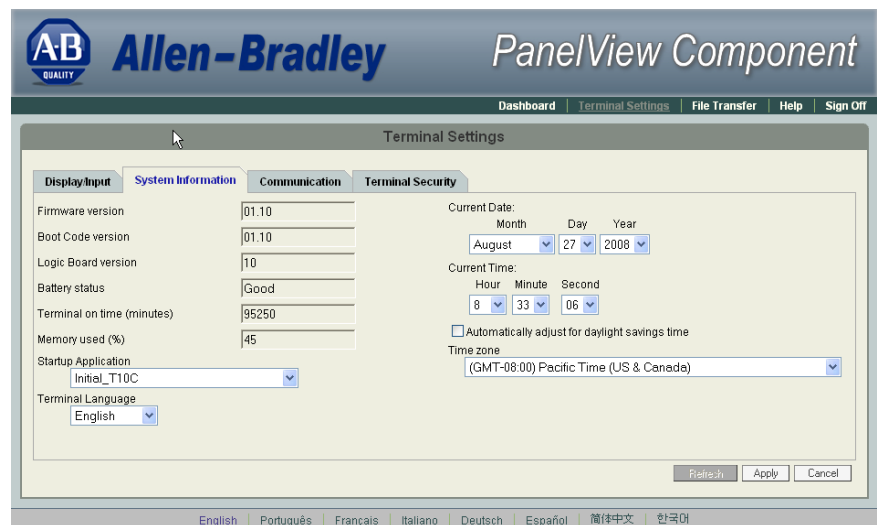

5. Click Apply, or click Cancel to restore the current setting.

Follow these steps to select or change the startup application from the C400, C600 or C1000 terminal.

1. Click File Manager from the Main menu.

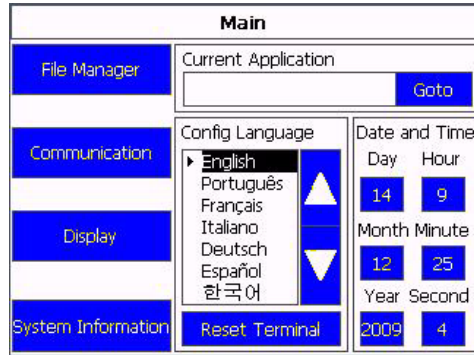

2. Select the location of the application from the Source list, either Internal, USB, or SD (for 2711C-T6C, 2711C-T6M, 2711C-T6T, 2711C-T10C only).

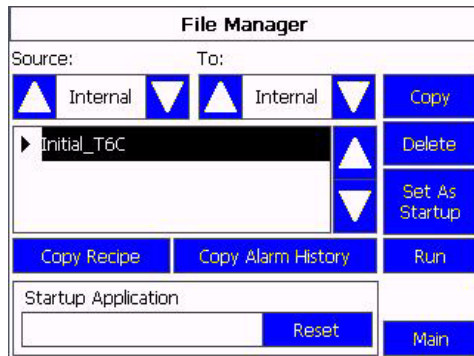

3. Select the name of the startup application from the Name list.
4. Click Set As Startup.

Follow these steps to select or change the startup application from the C200 or C300 terminal.

1. Click Startup Application from the Main menu.

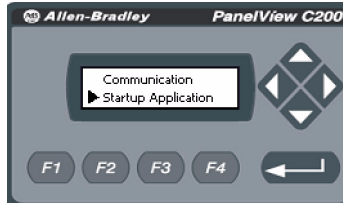

2. Press F1 to reset the startup application.

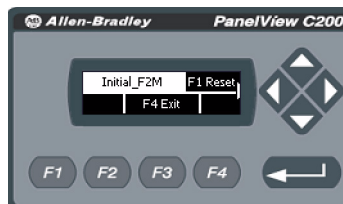

3. Press F4 to exit to the main menu.
4. Click on File Manager from the main menu.
5. Press F1 to select the source, either internal or USB.

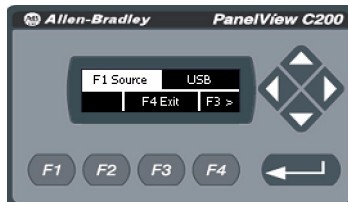

6. Press F3 to go to the list of applications and use the arrows to select the startup application.



7. Press F3, use the arrow keys to select Set Startup.

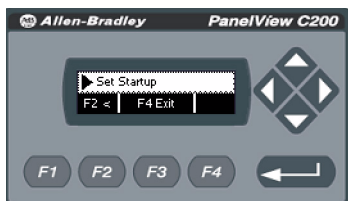

8. Press F4 to exit to the main menu.

Change the Date and Time

You can adjust the current date and time for terminal operations. The time is set in 24-hour format. You can also set the terminal to automatically adjust the time for daylight savings time.

Follow these steps to change the terminal date and time using the PanelView Explorer Startup window.

1. Go to the PanelView Explorer Startup window.
2. Click the Terminal Settings link.
3. Click the System Information tab.
4. Update the Current date fields.
5. Update the Current time fields.
6. Check Automatically adjust for daylight savings time if you want the terminal to adjust for daylight savings time.
7. Click Apply or click Cancel to restore the current terminal settings.

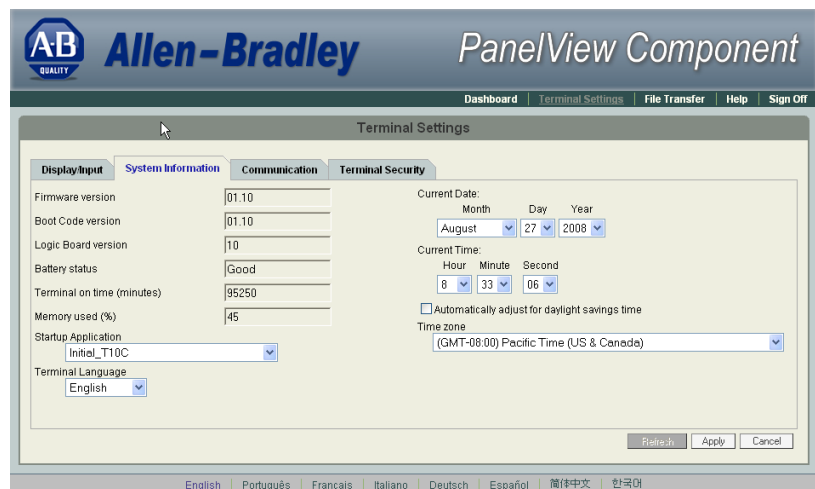

Follow these steps to change the terminal date and time from the C400, C600 and C1000 terminals.

1. Go to the Main configuration screen.

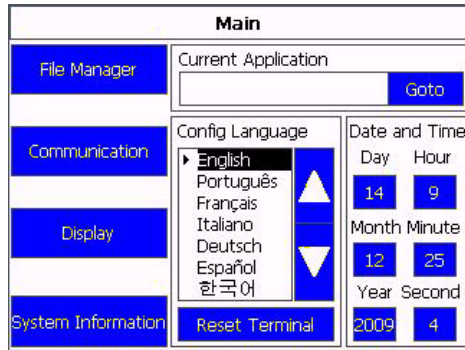

2. Click on the number next to what you want to change under the 'Date and Time' section.

A numeric keypad is displayed.

3. Select the numbers you want and click the enter key.

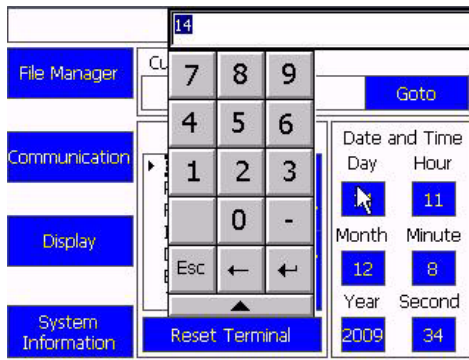

Change Ethernet Settings

You can establish an Ethernet connection between the connected PanelView Component terminal and computer using the Ethernet port or the host USB port on the terminal.

For the Ethernet port, IP addresses can be set dynamically by the network if Dynamic Host Configuration Protocol (DHCP) is enabled. If DHCP is disabled, the IP addresses must be entered manually.

IMPORTANT If a terminal is set for DHCP and is not on a network or is on a network that does not have a DHCP server (or the server is not available), it will automatically assign itself an Automatic Private IP Address (or auto IP address). The auto IP address will be in the range of 169.254.0.0...169.254.255.255.

The terminal makes sure the auto IP address is unique from any other auto IP address of other devices on the network. The terminal can now communicate with other devices on the network that have IP addresses in the 169.254.xxx.xxx range (and a subnet mask of 255.255.0.0).

IMPORTANT For the USB port, use the default IP address that is set when the terminal is connected to the computer. This address is 169.254.254.2. It is not recommended to change this setting.

Ethernet Settings

Parameter	Description
MAC ID	Read-only field that defines the MAC ID of the PanelView Component terminal. Each Ethernet device has a unique MAC ID.
Network Device Name	Unique name that identifies the terminal on the network.
IP Address	Unique address that identifies the terminal on the Ethernet network. The format of the IP address is xxx.xxx.xxx.xxx, for example, 10.90.95.30 The range of values for the first set of decimal numbers is 1...255 unless all fields are set to 000. The range of values for the last three sets of decimal numbers is 0...255.
Subnet Mask	Address that must be identical to the server subnet mask. The subnet mask is formatted like the IP address.
Default Gateway	Optional address that is formatted like the IP address.

If DHCP is enabled for the Ethernet port, the current fields show the IP addresses assigned by the network. You can assign IP addresses manually by disabling DHCP and entering addresses in the static fields.

Follow these steps to set a static IP address for the Ethernet port of the connected terminal using the PanelView Explorer Startup window.

1. Go to the PanelView Explorer Startup window.
2. Click the Terminal Settings link.
3. Click the Communication tab.

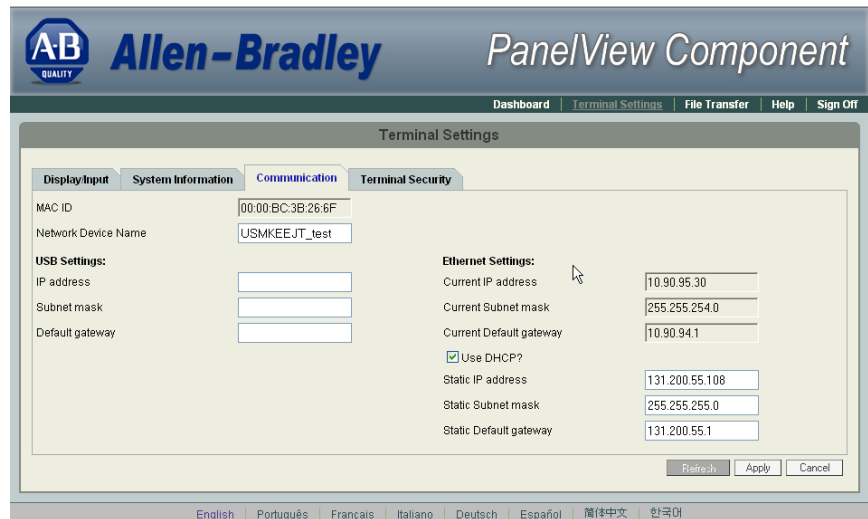

4. Uncheck the Use DHCP? option to manually enter IP addresses.
5. Enter an IP address in the Static IP address field.
6. Enter the default mask in the Static Subnet mask field.
7. Enter the default gateway in the Static Default gateway field.
8. Click Apply or click Cancel to restore the current IP address.

Follow these steps to set the IP address for the Ethernet port of the connected terminal from the C400, C600 and C1000 terminals.

1. Click Communication from the menu list.
2. Click Set Static IP Address.

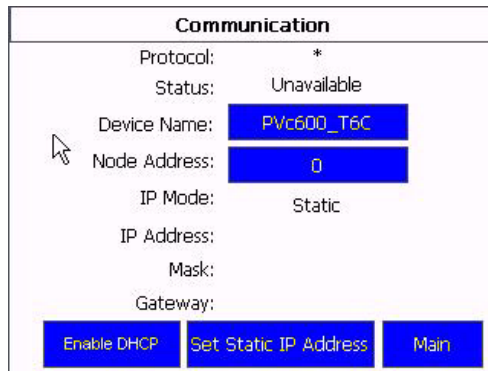

The screenshot shows the 'Communication' configuration screen. It has a title bar 'Communication'. Below it, the following fields are visible: Protocol: *, Status: Unavailable, Device Name: Pvc600_T6C, Node Address: 0, IP Mode: Static, IP Address: (empty), Mask: (empty), and Gateway: (empty). At the bottom, there are three buttons: 'Enable DHCP', 'Set Static IP Address', and 'Main'. A mouse cursor is pointing at the 'Set Static IP Address' button.

The Static IP Address screen appears.

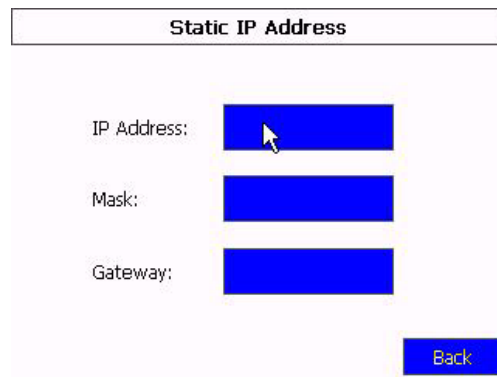

The screenshot shows the 'Static IP Address' configuration screen. It has a title bar 'Static IP Address'. Below it, there are three input fields: 'IP Address:', 'Mask:', and 'Gateway:'. Each field is currently empty and highlighted in blue. A mouse cursor is pointing at the 'IP Address' field. At the bottom right, there is a 'Back' button.

3. Click on the area next to IP Address to enter an IP address in the Static IP address field.
A keypad displays to let you enter the address.
4. Enter the subnet mask in the Static Subnet mask field.
5. Enter the default gateway in the Static Default gateway field.

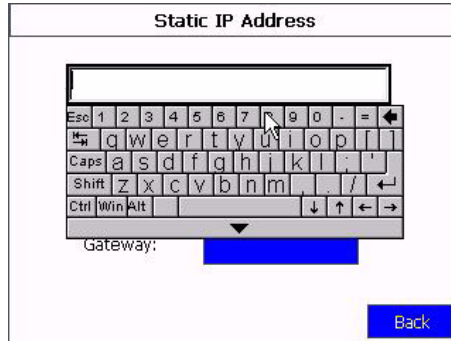

Enable Terminal Security

Use terminal security to restrict user access to the terminal configuration screens and the PanelView Explorer Startup window. For example, you can require users to enter a user name and password before accessing or editing an application.

Initially, the terminal and the PanelView Explorer Startup window are unsecured. To enable security, provide a password. The default user name is Admin. The new password takes effect the next time the terminal is restarted.

As long as security is enabled, any user that tries to access the terminal or the design-time environment while connected to the terminal must first log in with a valid user name and password.

The terminal also secures itself when idle. If terminal input is not received within the idle timeout period, the user is logged out. The user must log in again to access the terminal. The default terminal idle timeout is 30 minutes.

IMPORTANT Store your password in a safe place. If you forget the password, you will not be able to connect to the design environment.

Follow these steps to secure the design environment.

1. Go to the PanelView Explorer Startup window.
2. Click the Terminal Settings link.
3. Click the Terminal Security tab.

4. Check Terminal Security Enabled.

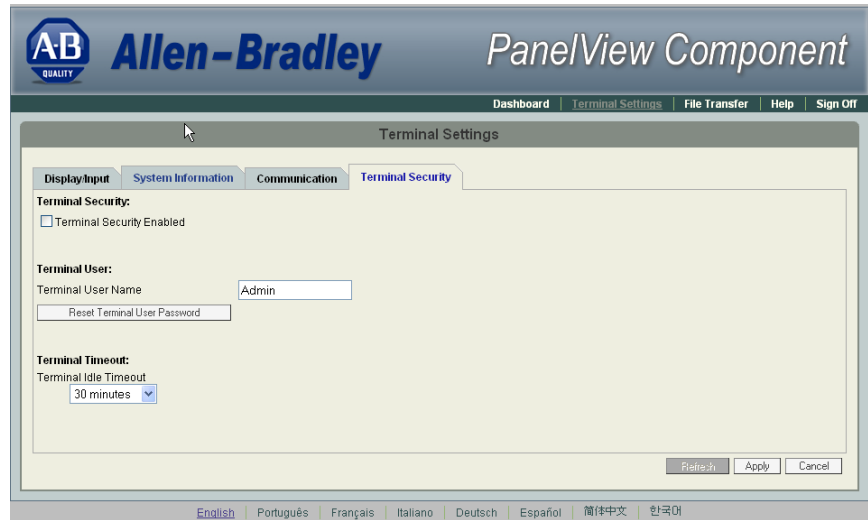

5. Optionally, enter a new Terminal User Name.

6. Click the Reset Terminal User Password button.

7. In the Reset Password dialog, enter a new password, confirm the password, then click OK.

TIP Terminal user names and passwords are limited to 15 characters.

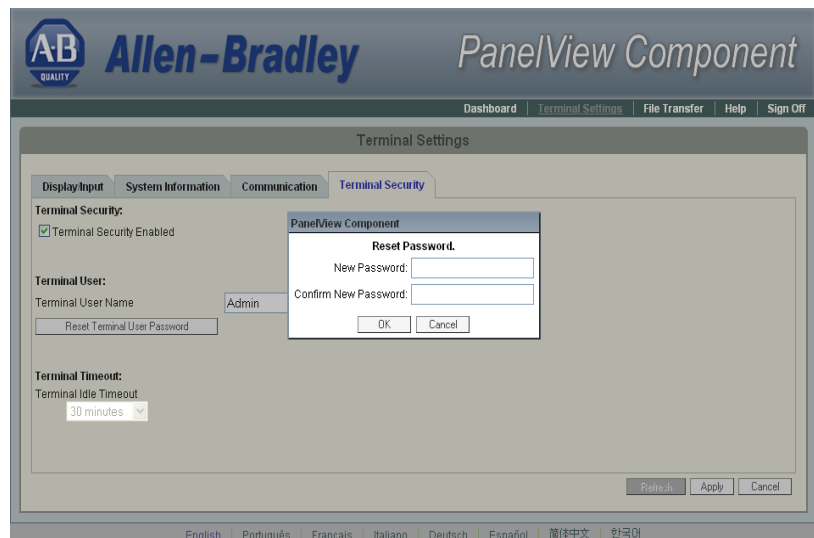

8. Select a new idle timeout from the Terminal Idle Timeout list, if needed, or click Cancel to restore the current idle timeout.

The new password and idle timeout value take effect when the terminal is restarted.

To disable security, uncheck the Terminal Security Enabled checkbox. The next time the terminal is restarted, the design environment is unsecured.

TIP The terminal user name and password is stored in a file that is separate from the application. You can transfer this file to other terminals without having to manually re-enter the information. Use the File Transfer link on the PanelView Explorer Startup window and transfer the Terminal User file from internal storage to your computer, USB or SD storage.

View System Information

You can view system information about your terminal including information about the firmware, boot code, logic board, battery status (if applicable), terminal on time, and memory used.

Follow these steps to view system information using the PanelView Explorer Startup window.

1. Go to the PanelView Explorer Startup window.
2. Click the Terminal Settings link.
3. Click the System Information tab.

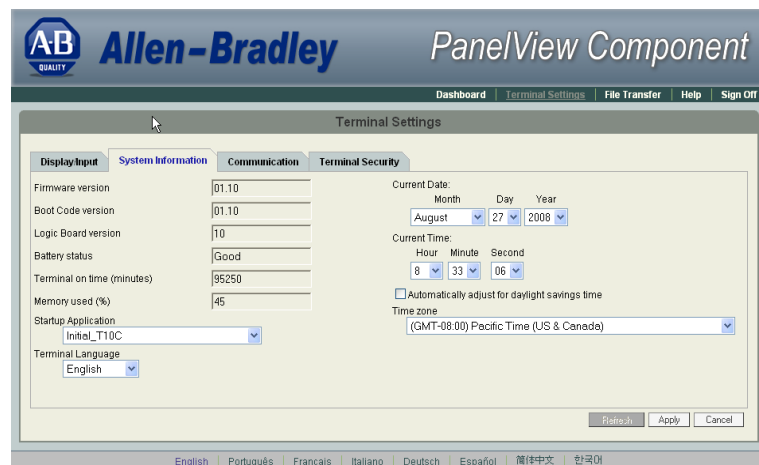

Follow these steps to view system information using the C200 or C300 PanelView Component terminal.

1. Select System Information from the menu list and press enter.

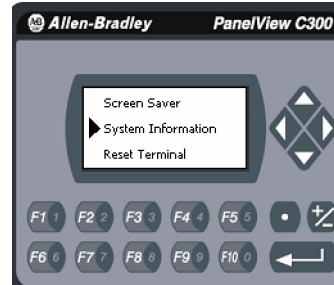

The system information appears.

2. Press F3 to see more information, press F2 to go back, or press F4 to exit to the main menu.

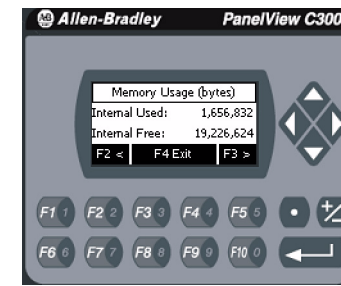
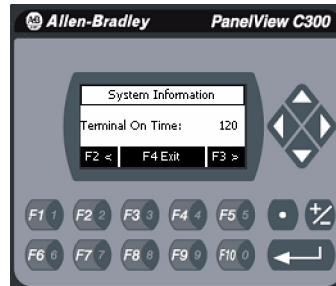
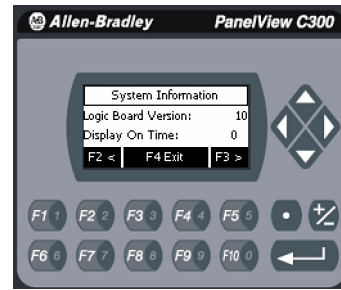
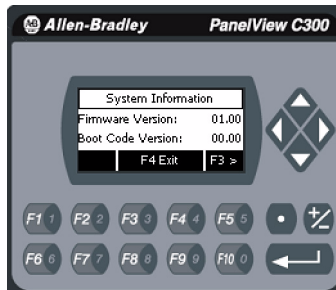

Follow these steps to view system information using the C400, C600 or C1000 PanelView Component terminal.

1. Click System Information from the menu list.

The system information screen displays firmware version, boot code version, logic board version, terminal on time, display on time, and battery status.

System Information	
Firmware Version:	01.30.006
Boot Code Version:	00.00
Logic Board Version:	10
Terminal On Time:	90
Display On Time:	0
Battery Status:	Not Available
Memory Usage (bytes)	
Internal Used:	1,804,288
Internal Free:	19,079,168
Application Used:	9,379,840
Application Free:	39,686,144

Managing Applications and Files

The PanelView Explorer Startup window has a File Transfer link for transferring files to and from terminal storage media. File names and tag names should start with an alpha character. Avoid starting names with numeric or special characters.

From the File Transfer view, you can:

- export or import applications, user-defined objects, images, the terminal security file, recipes, and fonts.
- import screen saver bitmap files
- export the alarm log from the currently running application.
- delete applications, user-defined objects, images, font files, terminal user file and recipes from terminal storage.

TIP For more information on creating applications and transferring files, see PanelView Component Operator Terminals Quick Start, publication [2711C-QS001](#).

A file transfer operation requires you to enter a source location, file type, and destination location.

- Source location - the location of the file you want to transfer. You can transfer a file from Internal Storage of the terminal, USB Storage, SD Storage, or My Computer.
- Source File Type - the type of file you want to transfer. The types of files you can transfer include PanelView Component applications, images, user-defined objects, fonts, recipes, and the terminal security file.

- Destination location - The location where you want to transfer the selected file. You can transfer a file to Internal Storage of the terminal, USB Storage, SD Storage, or My Computer.

IMPORTANT If transferring a file from or to USB or SD storage, verify that the USB flash drive or SD card is inserted in the terminal before starting the file transfer.

Transferring Applications

Applications created on one PanelView Component terminal can be used on other PanelView Component terminals. For example, you might design an application on one terminal and then distribute the application to other terminals for production.

Transferring an application is a two-step process.

- Export the application from the internal storage of the terminal to your computer, a USB Flash Drive, or SD card.
- Import the application from a computer, USB Flash Drive, or SD card to the internal storage of another terminal.

If the target terminal is a different type and size than the source terminal, some aspects of the application is converted and the remaining properties require updates. If trying to run an application, you are warned that the application was not created for the terminal, but you are given an option to continue or cancel unless the differences make it impossible to run the application (for example, an Ethernet application on a terminal without an Ethernet network connection).

PanelView Component applications are saved with a .cha file type. You cannot edit the file outside of the PanelView Explorer design environment.

Export an Application

During an export, the application file is transferred from internal storage of the terminal to a USB Flash Drive, SD card, or computer. The application is saved with its default name and .cha file type.

Follow these steps to export an application.

1. Go to the PanelView Explorer Startup window.
2. Click the File Transfer link.
3. Click the New transfer button.
4. Select Internal Storage as the source location of the application and click Next.

5. Select Application as the file type and click Next.
6. Select the application you want to export and click Next.
7. Select the destination for the application and click Transfer.
8. Click Save in the File Download dialog.
9. In the Save As dialog, accept the default file name and .cha file type, and click Save or enter another path.
10. Click Close when the download is complete.

Import an Application

During an import, the .cha application file is transferred from a USB Flash Drive, SD card, or computer to the internal storage of the terminal. The transfer operation communicates with the terminal to import the file.

You cannot overwrite an application while the application is running. You must unload the current application before overwriting the application. You can import applications while another is running.

Follow these steps to import an application.

1. Go to the PanelView Explorer Startup window.
2. If an application is currently loaded, click the stop sign above the dashboard to unload the current application.
3. Click the File Transfer link.
4. Click New Transfer.
5. Select the source location of the application and click Next.
6. Select Application as the file type and click Next.
7. Click Browse... to locate the .cha file you want to import.
8. Select Internal Storage as the destination and click Transfer.

The application is transferred to the internal storage of the terminal.

If an application with the same name already exists in internal storage, you will be asked if you want to replace the existing application.

If the target terminal is a different type and size than the source terminal, the application will be converted when in Edit, Test Run, or Run mode. The application may require updates in design mode before running properly.

Validate the Application

Before you can run an application on the PanelView Component, it is strongly recommended that you validate the application for errors and warnings. The application does not need to be error-free to run in the application, however, it is good practice to fix both errors and warnings to ensure expected system behavior.

1. Click the Validate icon on the application toolbar.



If the application passes validation, the Validation Results dialog looks like this.

If the application detects warnings or errors, the Validation Results dialog might look like this. For each warning or error, the message identifies the problem and its location. Correct the problem and then revalidate the application.

The status bar shows a Validation Reports link that you can open. It always shows the results of the last validation.

2. Click Close.

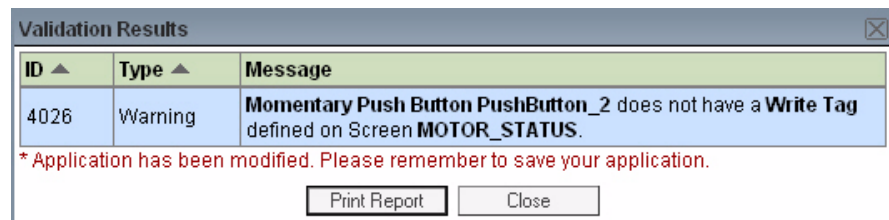
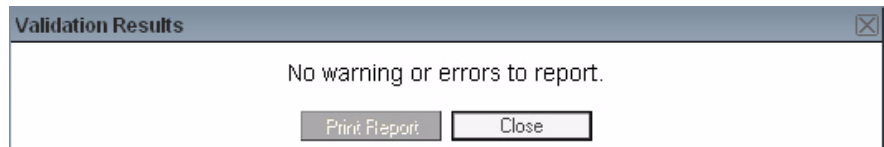

ATTENTION: Running a non-validated application may result in unexpected behavior.

3. Click the Save icon to save the application.



4. Click the Close Application icon to close the application.



Transferring User-defined Objects

You can transfer user defined objects (.chu), also known as library objects, created in one application to another terminal for use with other applications. In your application, the user-defined objects are added to the graphics library of the object palette. They are stored in terminal storage separate from the application and can be accessed from any application on the terminal (or emulator). The names of user-defined objects must begin with an alpha character.

Notes:

Install and Replace Components

Chapter Objectives

This chapter shows how to install, replace, or upgrade various components of the PanelView component terminals.

- SD memory card
- USB flash drive
- Battery replacement

SD Memory Card

The SD memory card can be inserted in this location on the C600 and C1000 terminals.

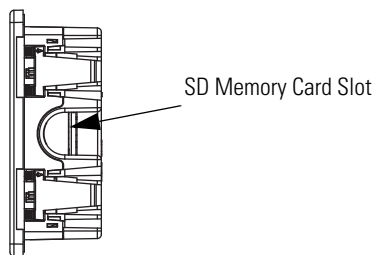

USB Flash Drive

The USB flash drive can be inserted in these locations on the terminals.

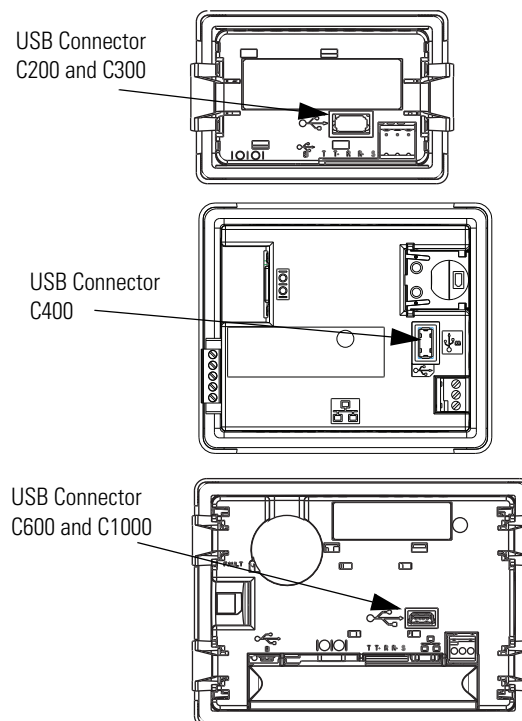

Battery Replacement

The C400, C600 and C1000 terminals contain a lithium battery that is intended to be replaced during the life of the product. The battery provides battery backup for the real-time clock. It is not used for application backup or retention.



ATTENTION: Verify that power has been removed from the terminal prior to replacing the battery. Work in a static free environment and wear a properly grounded electrostatic discharge (ESD) wristband.

ATTENTION: Be careful when touching any of the exposed electronic components to prevent damage from ESD.

ATTENTION: To avoid the danger of explosion, only replace the battery with 2711P-RY2032 or a manufacturer's equivalent such as the Matsushita or Duracell DL2032.

ATTENTION: For safety information on the handling of lithium batteries, see the Guidelines for Handling Lithium Batteries, publication [AG-5.4](#).

ATTENTION: Do not dispose of battery in a fire or incinerator. Dispose of used batteries in accordance with local regulations.

The battery is on the back of the terminals. No special tools are required to remove the battery cover and replace the battery.

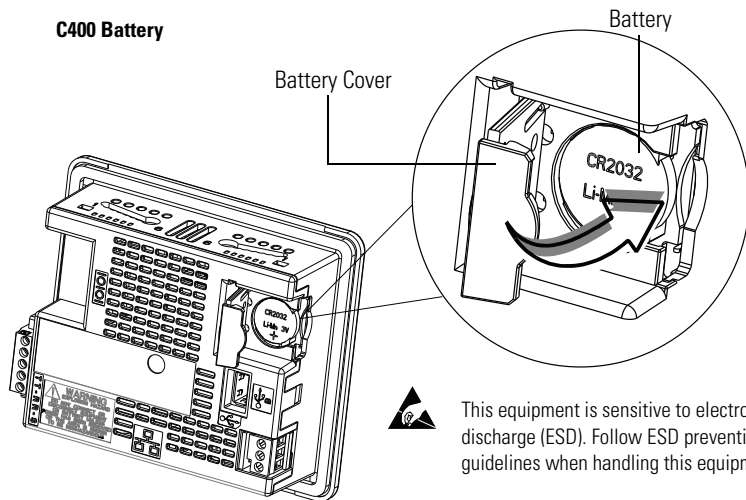

ATTENTION: At the end of its life, the used battery should be collected separately from any unsorted municipal waste and recycled.

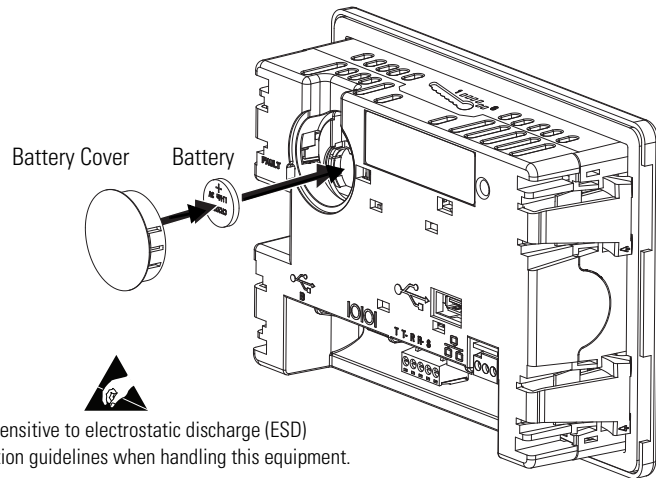

This equipment is sensitive to electrostatic discharge (ESD)
Follow ESD prevention guidelines when handling this equipment.



ATTENTION: At the end of its life, the used battery should be collected separately from any unsorted municipal waste and recycled.

Notes:

Cable Connections and Communication

Chapter Objectives

This chapter provides network and device connections for the terminals.

- Wiring and safety guidelines
- Connecting devices
- MicroLogix controller cable charts
- Ethernet connection
- Serial connections
- USB Ports

Wiring and Safety Guidelines

Use publication NFPA 70E Electrical Safety Requirements for Employee Workplaces, IEC 60364 Electrical Installations in Buildings, or other applicable wiring safety requirements for the country of installation when wiring the devices. In addition to the NFPA guidelines:

- connect the device and other similar electronic equipment to its own branch circuit.
- protect the input power by a fuse or circuit breaker rated at no more than 15 A.
- route incoming power to the device by a separate path from the communication lines.
- cross power and communication lines at right angles if they must cross.

Communication lines can be installed in the same conduit as low-level dc I/O lines (less than 10V).

- shield and ground cables appropriately to avoid electromagnetic interference (EMI).

Grounding minimizes noise from EMI and is a safety measure in electrical installation.

For more information on grounding recommendations, refer to the National Electrical Code published by the National Fire Protection Association.



Connecting Devices

Use these cables for connecting devices to PanelView Component terminals.

Cables for PanelView Component Terminals

Cat. No.	Description	For Use With
2711C-CBL-UU02	USB-A host to USB-B device cable, 2 m (6.56 ft)	C200, C300, C400, C600, C1000
2711P-CBL-EX04	Ethernet crossover CAT5 cable 4.3 m (14 ft)	C400, C600, C1000
2711C-RCSD	USB to SD adapter with secure digital (SD) card	C200, C300, C400, C600, C1000
1747-CP3	Serial 9-pin D-shell to 9-pin D-shell null modem cable	C200, C300, C400, C600, C1000
1761-CBL-PM02	Serial 9-pin D-shell to 8-pin mini DIN cable, 2 m (6.56 ft)	C200, C300, C400, C600, C1000
2711C-CBL-AB03	RS-485 5-pin to RJ45 cable	C200, C300, C600, C1000

MicroLogix Controller Cable Charts

The chart provides a summary of terminal connections to controllers and network interface modules.

PanelView Component Terminals to MicroLogix Controllers

Protocol	PanelView Component Port	MicroLogix (8-pin Mini DIN) 1000, 1100, 1400, 1200LSP, 1500LSP (Ch 0)	MicroLogix (9-pin D-shell) 1500LRP (Ch 1)	MicroLogix 1100/1400 RS485 (1763-NC01)	MicroLogix 1100/1400 Ethernet
DF1	RS232	1761-CBL-PM02	1747-CP3	N/A	N/A
DH-485	RS232	1761-CBL-PM02	1747-CP3	Use AIC+ module (1761-NET-AIC) connect to port 3	N/A
	RS485 ⁽¹⁾	N/A	N/A	Belden 3106A or #9842 or equivalent	N/A
Modbus	RS232	1761-CBL-PM02	1747-CP3	Use AIC+ module (1761-NET-AIC) connect to port 3	N/A
Ethernet (MicroLogix/ENI)2	Ethernet	N/A	N/A	N/A	CAT 5 Ethernet

⁽¹⁾ RS485 is non-isolated and is recommended for connecting to only one device with an isolated port.

Ethernet Connection

The C400, C600 and C1000 terminals have an Ethernet port that supports:

- communication to a controller.
- connection to a computer for application design.

Ethernet Connector

The base-configured unit of the terminals has an RJ45, 10/100 Base-T connector for Ethernet network communication.

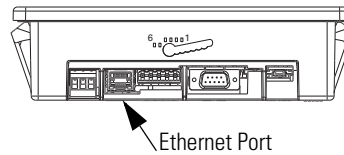

Ethernet Connector Pinout

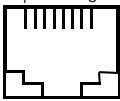
Pin	Pin	Pin Name
Looking into RJ45 Connector 	1	TD+
	2	TD-
	3	RD+
	4	NC
	5	NC
	6	RD-
	7	NC
	8	NC
	Shield Connection	Chassis Gnd

Either a standard Ethernet cable or crossover cables such as 2711P-CBL-EX04 can be used when connecting directly to a logic controller or switch.

Cables

The PanelView Component terminals require category 5 twisted-pair cables. The maximum cable length between the terminal's Ethernet port and a 10/100 Base-T port on an Ethernet hub (without repeaters or fiber) is 100 m (328 ft). In industrial applications, keep the cable length to a minimum.

For additional information, refer to the EtherNet/IP Media Planning and Installation Manual, publication [ENET-IN001](#).



Security Considerations

IGMP (Internet Group Management Protocol) is used for IPv4 multicast. A multicast is communication between a single sender and multiple receivers on a network. IGMP is used to exchange membership status data between IPv4 routers that support multicasting and members of multicast groups. A router is an intermediary device on a communication network that expedites message delivery by finding the most efficient route for a message packet within a network, or by routing packets from one sub-network to another. A sub-network is a separate part of an organization's network identified through IP addressing.

PanelView Component terminals provide level 2 (full) support for IPv4 multicasting (IGMP version 2) as described in RFC 1112 and RFC 2236.

SNMP (Simple Network Management Protocol) is used for internal network management and is not supported.

Ports 137 and 138 are normally open to support the NetBIOS protocol used by Windows CE.NET similar to other Microsoft and IBM network operating systems.

Serial Connections

The terminals have a multi-purpose serial RS-232 port that supports:

- DH-485 communication through a serial connection.
- DF1 full-duplex communication with controllers using direct connections or modem connections.
- third-party point-to-point communication.

The serial port on the terminal is a 9-pin, male, RS-232 connector. An example with the 1761-CBL-PM02 cable is shown here:

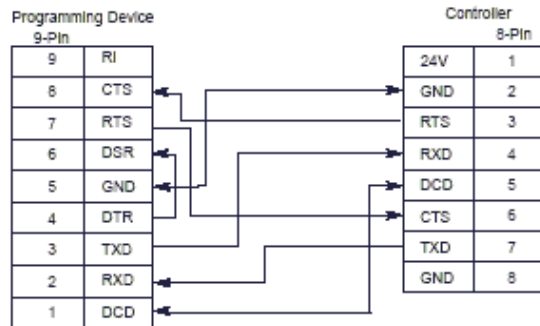
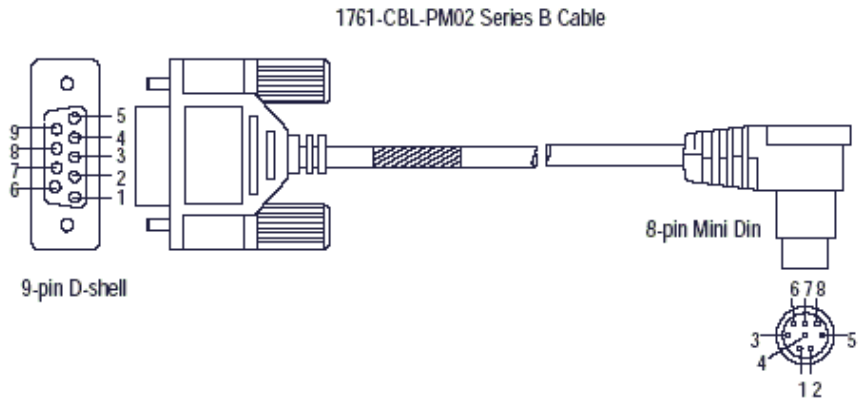

The maximum cable length for serial communication is 15.24 m (50 ft) at 19.2 Kbps

RS-422/RS-485 Port

The RS-422/RS-485 port is a nonisolated port that supports point-to-point communication.

RS-422/RS-485 Connector Pinout

Pin	Signal
1	T
2	T-
3	R
4	R-
5	S (Shield)

The RS422/485 port has integrated 121 ohm termination between the R and R-signal pair. This value is compatible with RS422 and RS485 electrical specifications. Additional termination on the PanelView Component end of communication cables is not required.

USB Ports

The terminals have a USB device and USB host port.

USB Host Port

You can power USB peripherals directly from the PanelView component terminal. If the USB peripheral is not powered directly from the PanelView USB port either:

- install the USB peripheral in the same enclosure as the PanelView terminal and make sure it is connected to the same ground system.
- connect to the USB peripheral through a galvanically isolated hub.

You can use the USB host port to connect a USB Flash drive to transfer application files, fonts, and images.

IMPORTANT

Some USB flash drives might not be compatible with the PanelView Component terminal and might not support file transfers or firmware upgrades. The 2711C-RCSD memory card is tested with the PanelView Component terminal to ensure compatibility.



ATTENTION: Removing the USB flash drive or SD card, from the PanelView Component terminal, while a firmware upgrade is in process, could corrupt the firmware and make the terminal unusable. Take precautions to prevent the USB flash drive or SD card from being accidentally disconnected. Also, do not power off the terminal while a firmware upgrade is in progress.

ATTENTION: USB hubs can produce unexpected behaviors and as a result are not recommended.

USB Device Port

You must connect the PanelView USB device port to a USB host that is connected to the same ground system. This port can be used for connecting to a computer to transfer applications, fonts, and images.

IMPORTANT Before connecting your computer to the USB port of the PanelView Component terminal, you must first install the Allen-Bradley PanelView USB remote NDIS Network Device driver on your computer.

IMPORTANT The USB RNDIS driver is only supported on Windows XP and Windows Vista operating systems. It is not supported by the Windows 2000 operating system.

Install the USB Driver

Follow these steps to install the USB driver on your computer.

1. Go to <http://ab.rockwellautomation.com/Graphic-Terminals/2711C-PanelView-Component-C400-Terminals> to download the USB driver.
2. Run the installer, PanelView Component USB Driver.exe. The installer extracts and runs an Install Shield Wizard.

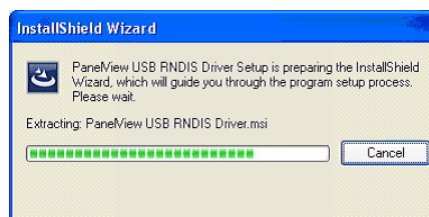

3. Click Next when the Welcome dialog box appears.

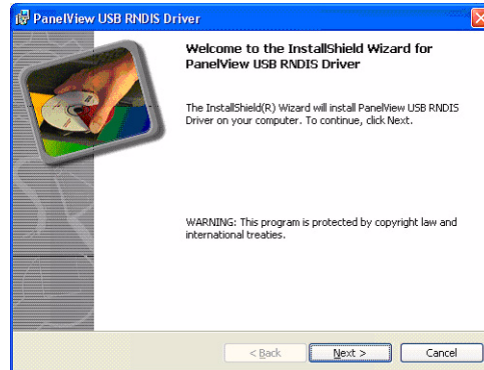

4. Click Install to begin the installation of the PanelView USB RNDIS Driver.

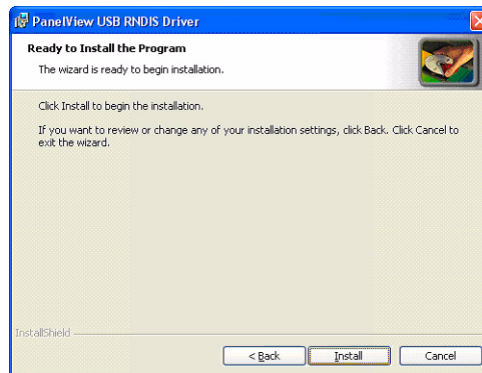

The progress indicator shows that the driver is installing.

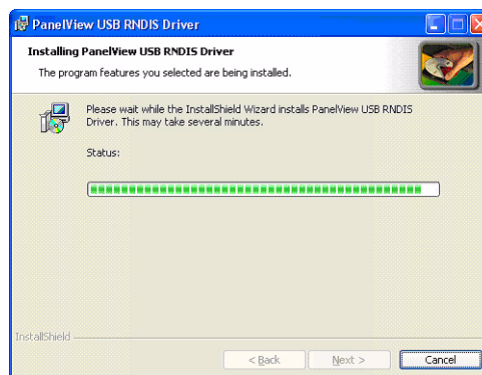

5. Click Next when the Device Driver Installation Wizard dialog box appears.



The drivers install.

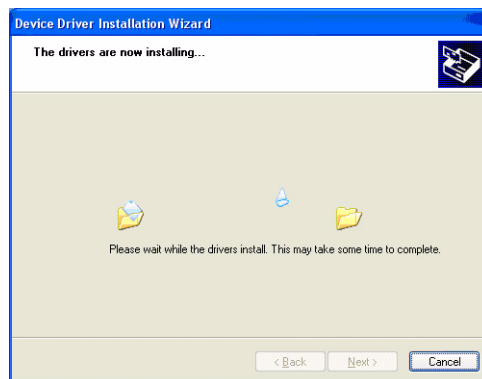

6. If the Windows Logo Test warning dialog box is displayed, click Continue Anyway.

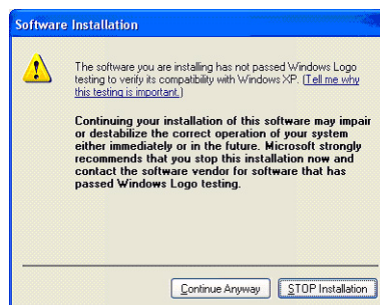

7. Click Finish in the Device Driver Installation Wizard dialog box.



8. Click Finish in the PanelView USB RNDIS Driver dialog box.

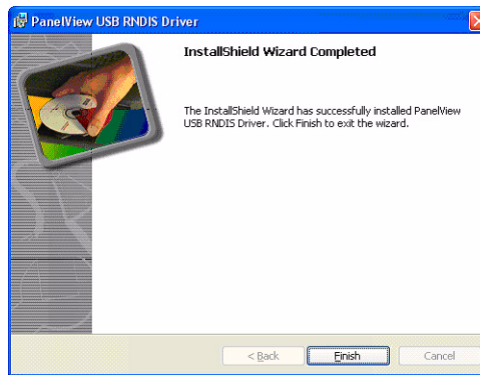

The drivers are now installed.

Configure the Terminal for USB Connection

Follow these steps to configure your terminal to be connected through a USB port to a computer.

1. Connect the USB host port on the computer to the USB device port on the terminal.

IMPORTANT

The terminal should be directly connected to a USB port on the computer. Do not connect through some other device, such as a USB port on a monitor, keyboard, or laptop computer docking station.

2. Power-up the terminal.

When the terminal connects to the computer for the first time, the new USB device (the PanelView Component terminal) is discovered by the Windows Found New Hardware Wizard that guides you through the installation.

There are two instances of the driver. There is one for the Boot Loader and one for the Windows CE Operating System. The USB IP address is always 169.254.254.2.



3. Choose Install the software automatically and click next.

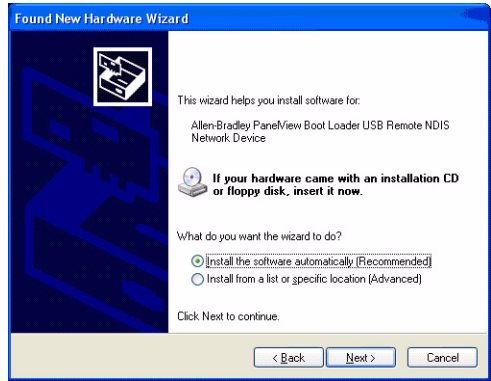

The wizard searches for the files.

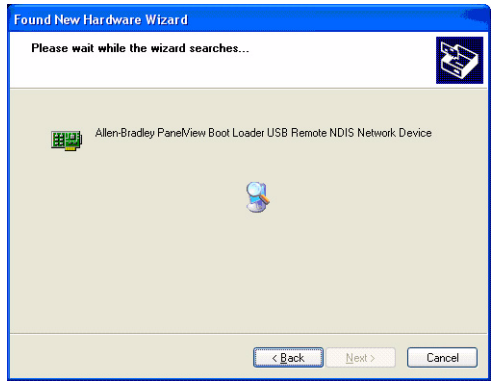

4. If the Windows Logo Test warning dialog box is displayed, click Continue Anyway.

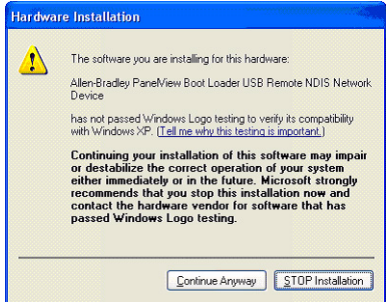

The software installs.

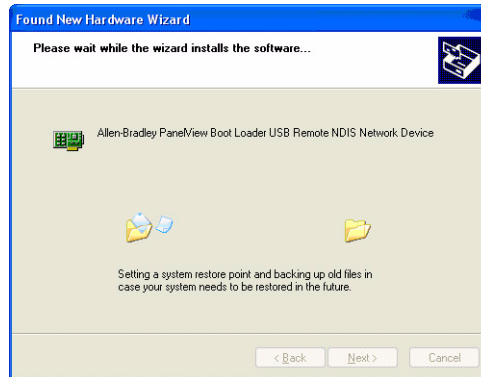

5. Click Finish in the Completing the Found New Hardware Wizard dialog box for the boot loader.



6. Click Next when the Found New Hardware Wizard dialog box for the PanelView USB Remote NDIS Network Device appears.



7. Choose Install the software automatically and click next.

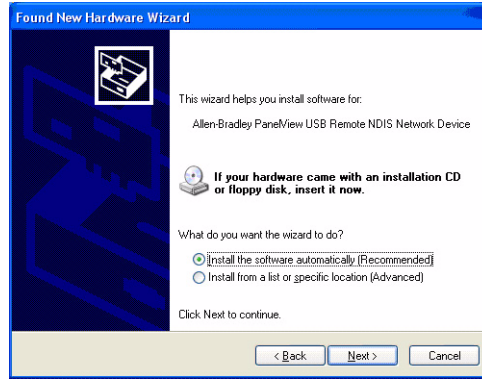

The wizard searches for the files.

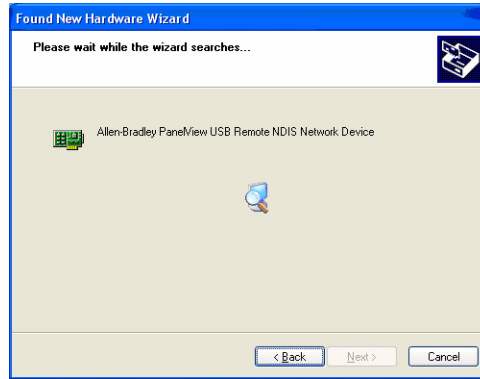

8. If the Windows Logo Test warning dialog box is displayed, click Continue Anyway.



The software installs.

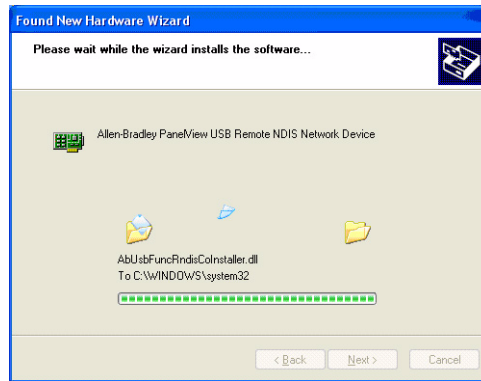

9. Click Finish in the Completing the Found New Hardware Wizard dialog box for the PanelView USB Remote NDIS Network Device.



Driver Installation Note for Windows 7 and Windows Vista

1. During the initial installation of the USB RNDIS boot loader driver, you may see the dialog box reporting an unsuccessful installation, as shown here.

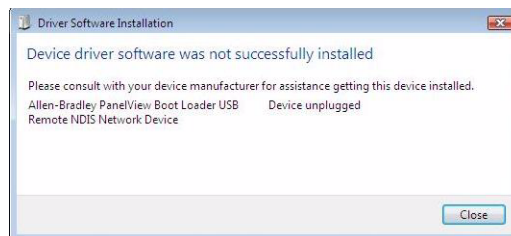

If so, ignore this dialog box and click Close to continue installing the driver for Windows.

2. After the driver installation is complete, you may see a dialog box similar to the one shown here.

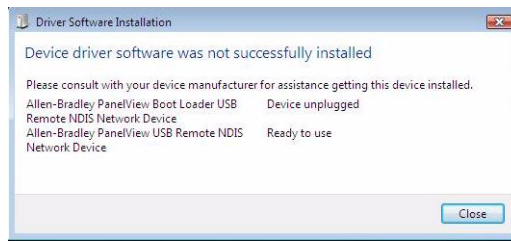

Cycle power to the terminal and reconnect the USB cable.

3. This dialog box appears.

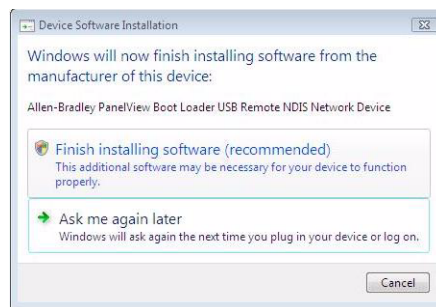

4. Select the Finish installing software (recommended) option to continue installing the boot loader driver.

5. Installation is complete when this dialog box appears.

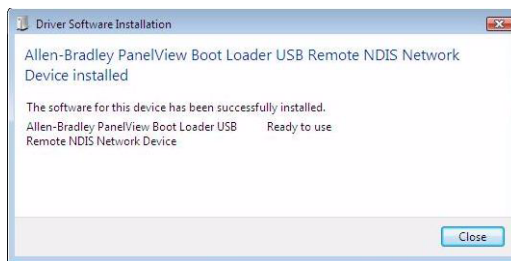

Upgrade Firmware

Chapter Objectives

This chapter provides topics on how to upgrade firmware in the terminal.

- Prepare for firmware upgrade
- Upgrade firmware using a removable storage device

The firmware upgrade runs an executable script on a removable storage device such as a USB flash drive or an SD card that copies a firmware image into the flash memory of the terminal.

Prepare for Firmware Upgrade

Follow these steps before starting a firmware upgrade.

1. Backup applications and library objects from the terminal.
2. Click Stop to unload the currently loaded application.
The stop sign shown when an application is loaded and in Edit/Test/Run mode.

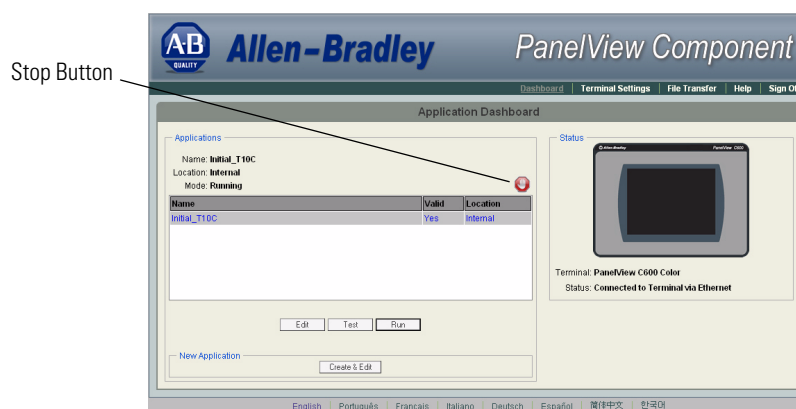

To stop an application from the terminal, go to the main configuration screen and reset the terminal and then reboot.

If you have not saved changes to the application, you are prompted to do so. Once the application is unloaded, the terminal displays the Configuration screen.

3. Close the web browser connected to the terminal.

4. Verify the existing firmware revision of the terminal by looking in the Configuration Screens, and compare to the firmware revision of the file to make sure you are performing the desired upgrade.

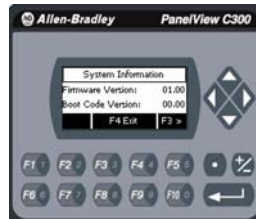

System Information	
Firmware Version:	01.30.006
Boot Code Version:	00.00
Logic Board Version:	10
Terminal On Time:	90
Display On Time:	0
Battery Status:	Not Available
Memory Usage (bytes)	
Internal Used:	1,804,288
Internal Free:	19,079,168
Application Used:	9,379,840
Application Free:	39,686,144

Refer to [View System Information on page 47](#) for instructions on how to view the current firmware version.

Firmware Installation Using Removable Storage Device

The terminal can install firmware from a removable storage device; either a USB flash drive or an SD storage card. The firmware consists of an Autorun executable and firmware images that is downloaded from the PanelView Component technical support website.

<http://ab.rockwellautomation.com/Graphic-Terminals/2711C-PanelView-Component-Terminals>.

The firmware installation starts when the storage device is inserted either while the terminal is running, or when the terminal is powered on. During the firmware installation, you can upgrade or downgrade one or more of these firmware images:

- Windows CE Operating System
- Application
- Communication
- Asian font, Chinese or Korean

The terminal has a firmware partition that accommodates one user-installable Asian font. A Simsun Chinese font is factory-installed. Firmware images for the Simsun Chinese font and Gulim Korean font can be downloaded from the technical support website.

TIP The currently installed Asian font firmware image is visible in the list of Configuration Languages on the Main Screen.



ATTENTION: Removing the USB flash drive or SD card, from the PanelView Component terminal, while a firmware upgrade is in process, could corrupt the firmware and make the terminal unusable. Take precautions to prevent the USB flash drive or SD card from being accidentally disconnected. Also, do not power off the terminal while a firmware upgrade is in progress, or during the subsequent boot-up process that follows the firmware upgrade.

ATTENTION: USB hubs can produce unexpected behaviors and as a result are not recommended.

IMPORTANT

Some USB flash drives might not be compatible with the PanelView Component terminal and might not support file transfers or firmware upgrades. The catalog number, 2711C-RCSD memory card was tested with the PanelView Component terminal to ensure compatibility.

TIP

Only the C600 and C1000 support the SD Storage Card.

TIP

The firmware version consists of a major and minor two-digit number, and a three-digit revision number, separated by a period (for example, 01.23.456 where 01 is the major, 23 is the minor, and 456 is the revision). The firmware version for the terminal is displayed on the System Information screen.

TIP

The firmware version information appears in the filename of the firmware file that is downloaded from the PanelView Component technical support website, for example, 2711C.FUP.01.23.EXE.

TIP

After upgrading your firmware, you should clear your browser cache.

To clear cache in the Firefox browser, select Tools > Clear Private Data. Verify the Cache checkbox is checked and click the Clear Private data button.

To clear cache in the Internet Explorer browser, select Tools > Internet Options. On the General tab, click the Delete button under Temporary Internet Files to delete all temporary internet files, including offline content.





ATTENTION: Changing the firmware will likely change the behavior of the terminal. Be aware of the firmware versions for the terminal versus the new firmware that is on the computer, and be informed of the expected behavior after the new firmware is installed on the terminal.

Prepare the Storage Device

Follow these steps to prepare the storage device to transfer firmware files.

1. Insert the storage device into a USB host port or an SD card slot that is on your computer.
2. Open a web browser and access the PanelView Component technical support website.
3. Locate the new firmware file.
4. Observe the firmware version information that is in the name of the firmware file and confirm that this is the new, desired firmware.
5. Download the firmware file to a folder on your computer, then open the file and unpack the contents of the firmware file to an SD card or USB flash drive root directory.

Install the Firmware from the Storage Device

Follow these steps to transfer firmware files from a storage device.

1. Open the system information screen to see the firmware version information for the terminal.

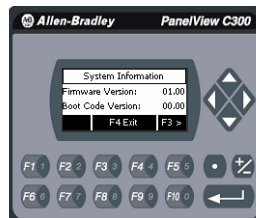

System Information	
Firmware Version:	01.00.006
Boot Code Version:	00.00
Logic Board Version:	10
Terminal On Time:	90
Display On Time:	0
Battery Status:	Not Available
Memory Usage (bytes)	
Internal Used:	1,804,288
Internal Free:	19,079,168
Application Used:	9,379,840
Application Free:	39,686,144

[Refer to View System Information on page 47](#) for instructions on how to view the current firmware version.

2. Insert the storage device into a USB host port or the SD card slot that is on your terminal.

- When prompted to run the Autorun, press Yes or the F1 key.

The splash screen appears and the progress bar indicates a firmware installation is in process.

IMPORTANT Do not remove the SD card or USB flash drive until upgrade - OK is displayed.

When the firmware installation is complete and successful, the progress bar stops with the success code OK.

- Remove the storage device and reboot the terminal.
- Open the system information screen to see the firmware version that is expected after the installation.

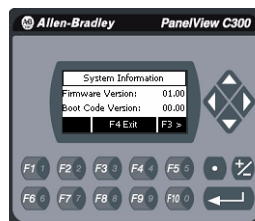

System Information	
Firmware Version:	01.30.006
Boot Code Version:	00.00
Logic Board Version:	1.0
Terminal On Time:	90
Display On Time:	0
Battery Status:	Not Available
Memory Usage (bytes)	
Internal Used:	1,804,288
Internal Free:	19,079,168
Application Used:	9,379,840
Application Free:	39,686,144

[Refer to View System Information on page 47](#) for instructions on how to view the current firmware version.

Notes:

Troubleshoot the System

Chapter Objectives

This chapter provides information on how to isolate and correct common operating problems with system components.

- View system information
- Alerts
- Troubleshooting

View System Information

You can view current system information for the connected terminal. You should provide this information when contacting technical support.

- Operating system version
- Firmware version
- Hardware version number
- Status of the battery
- Total power on time
- Memory used in KBytes

Follow these steps to view the system information on your terminal.

1. Go to the PanelView Explorer Startup window.
2. Click the Terminal Settings link.
3. Click the System Information tab.
4. View the information.
5. Click Apply.

Alerts

The terminal displays alerts at times during operation. The alert consists of an ID number and a description. Follow the corrective action to resolve the alert.



PanelView Component Terminal Alerts

Category	ID	Description	Corrective Action
Communication	2	Data Access Error for Alias /*S:0 Param2*/, Controller /*S:0 Param3*/, Address is /*S:0 Param4*/, Communication Flag is /*S:0 Param1*/ The terminal is having trouble reading the external tag at this controller and address.	Check that the communication network cable is connected. If new ladder logic is downloading to the controller, you could see this message. After the download, communication should run normally. Verify you have good communication to the controller. If a remote device not responding alert was present, then all external tags being actively scanned will generate this alert. Is the address configured in the controller? If so, make sure all addresses of external tags to this controller are configured at the controller. If one address is outside of the range, a block of addresses might show this condition. If the address is configured as write only at the controller, this address cannot be read. Set this external tag as write only and remove panel devices from your application that want to display data from this external tag.
Communication	3	Communication Server Error	Contact technical support providing this data. ID1-/*S:0 Param1*/, ID2-/*S:0 Param2*/, P1-/*S:0 Param3*/ Reboot the terminal.
Communication	4	Communication Server Error	Contact technical support providing this data. ID1-/*S:0 Param1*/, ID2-/*S:0 Param2*/, P1-/*S:0 Param3*/, P2-/*S:0 Param4*/ Reboot the terminal.
Communication	5	Communication Server Error	Contact technical support providing this data. ID1-/*S:0 Param1*/, ID2-/*S:0 Param2*/, P1-/*S:0 Param3*/, P2-/*S:0 Param4*/, P3-/*S:0 Param5*/ Reboot the terminal.
Communication	6	Communication Server Error	Contact technical support providing this data. ID1-/*S:0 Param1*/, ID2-/*S:0 Param2*/, P1-/*S:0 Param3*/, P2-/*S:0 Param4*/, P3-/*S:0 Param5*/, P4-/*S:0 Param6*/ Reboot the terminal.
Communication	7	Communication Server Error	Contact technical support providing this data. ID1-/*S:0 Param1*/, ID2-/*S:0 Param2*/, P1-/*S:0 Param3*/, P2-/*S:0 Param4*/, P3-/*S:0 Param5*/, P4-/*S:0 Param6*/, P5-/*S:0 Param7*/ Reboot the terminal.

PanelView Component Terminal Alerts

Category	ID	Description	Corrective Action
Communication	8	Communication Server Error	<p>Contact technical support providing this data. ID1-/*S:0 Param1*/, ID2-/*S:0 Param2*/, P1-/*S:0 Param3*/, P2-/*S:0 Param4*/, P3-/*S:0 Param5*/, P4-/*S:0 Param6*/, P5-/*S:0 Param7*/, P6-/*S:0 Param8*/</p> <p>Reboot the terminal.</p>
Communication	9	Communication Server Error	<p>Contact technical support providing this data. ID1-/*S:0 Param1*/, ID2-/*S:0 Param2*/</p> <p>Reboot the terminal.</p>
Communication	10	<p>Write Error for Alias /*S:0 Param2*/, Controller /*S:0 Param3*/, Address is /*S:0 Param4*/, Communication Flag is /*S:0 Param1*/</p> <p>The terminal is having trouble writing the external tag at this controller and address.</p>	<p>Verify you have good communication to the controller.</p> <p>Verify that the communication network cable is connected.</p> <p>If new ladder logic is downloading to the controller, you could see this message. After the download, communication should run normally.</p> <p>If a remote device not responding alert is present, then all external tags being written to will generate this alert.</p> <p>Is the address configured in the controller? If the address is configured as read only at the controller, this address can not be written to. Set this external tag as read and remove panel devices from your application that can write data to this external tag.</p>
Communication	11	<p>Read Error for Alias /*S:0 Param2*/, Controller /*S:0 Param3*/, Address is /*S:0 Param4*/, Communication Flag is /*S:0 Param1*/</p> <p>The terminal is having trouble reading the external tag at this controller and address.</p>	<p>Verify you have good communication to the controller.</p> <p>Verify that the communication network cable is connected.</p> <p>If new ladder logic is downloading to the controller, you could see this message. After the download, communication should run normally.</p> <p>If a remote device not responding alert was present, then all external tags being read from will generate this alert.</p> <p>Is the address configured in the controller? If the address is configured as write only at the controller, this address can not be read from. Set this external tag as write and remove panel devices from your application that can read data from this external tag.</p>

PanelView Component Terminal Alerts

Category	ID	Description	Corrective Action
Communication	27	Remote Device /*S:0 Param1*/ is Not Responding	<p>Verify all network connections are correct.</p> <p>Verify that the communication network cable is connected.</p> <p>If new ladder logic is downloading to the controller, you could see this message. After the download, communication should run normally.</p> <p>Verify that the network address of the controller matches the terminal controller address configured in the Communication tab.</p> <p>In the Communication tab, verify that the protocol specifications are correct, such as communication rate, data bits, stop bits. These are all protocol specific.</p>
Communication	28	Invalid Data Address /*S:0 Param1*/	This is not syntactically a valid address.
Communication	30	Bad address in block /*S:0 Param1*/ to /*S:0 Param2*/ on device /*S:0 Param3*/	This can occur when a write only address for a controller has been set for read/write in the external tag of the terminal. Param1 to Param2 specifies the address block having the issue. Somewhere within the range is where the write only address is defined in a PanelView external tag. Set the external tag to write.
Recipe	1001	Recipe upload started.	This message is for informational purposes. No corrective action needed.
Recipe	1002	Recipe save failed. Cause: Recipe in Table has not been modified.	Make sure that the recipe table is modified before the save operation is done.
Recipe	1003	Recipe save had errors.	This message is for informational purposes. No corrective action needed.
Recipe	1004	Recipe save completed successfully.	This message is for informational purposes. No corrective action needed.
Recipe	1005	Recipe download failed. Cause: Operation cancelled.	This message is for informational purposes. No corrective action needed.
Recipe	1006	Recipe download started.	This message is for informational purposes. No corrective action needed.
Recipe	1007	Recipe download completed with errors.	This message is for informational purposes. No corrective action needed.
Recipe	1008	Recipe download completed successfully.	This message is for informational purposes. No corrective action needed.

PanelView Component Terminal Alerts

Category	ID	Description	Corrective Action
Recipe	1009	Recipe Download failed. Cause: Unable to write to /*S:0 Param1*/.	Check for: Communication errors. Bad data point specification. The ingredient value written is outside the Low EU and High EU limits of the numeric data point assigned. (These are optional OPC defined properties representing data point minimum and maximum values). The ingredient value could not be converted to the type of the data point assigned.
Recipe	1010	Recipe upload completed with errors.	This message is for informational purposes. No corrective action needed.
Recipe	1011	Recipe upload completed successfully.	This message is for informational purposes. No corrective action needed.
Recipe	1012	Recipe restore failed. Cause: Operation cancelled.	This message is for informational purposes. No corrective action needed.
Recipe	1013	The status data point for Recipe /*S:0 Param1*/ operation could not be written to. Data Point= /*S:0 Param2*/	Check for: Communication errors Bad status data point specification The status value written is outside the Low EU and High EU limits of the numeric data point assigned. (These are optional OPC defined properties representing data point minimum and maximum values). The status value could not be converted to the type of the data point assigned
Recipe	1014	Recipe download failed. Cause: The value /*S:0 Param1*/ is less than the minimum value /*S:0 Param2*/ allowed for ingredient /*S:0 Param3*/	Correct the dataset value.
Recipe	1015	Recipe /*S:0 Param1*/ failed. Cause: No Selector on display.	Add a recipe selector device to the screen.
Recipe	1016	Recipe /*S:0 Param1*/ failed. Cause: No DataSet Selector on display.	Add a dataset selector device to the screen.
Recipe	1017	Recipe /*S:0 Param1*/ failed. Cause: No Table on display.	Add a Recipe Table Panel device to the Screen.
Recipe	1018	Recipe /*S:0 Param1*/ operation was not started because the system is currently busy performing another Recipe operation.	Wait for a recipe operation to complete before starting the next recipe operation.
Recipe	1019	Recipe /*S:0 Param1*/ failed. Cause: No recipe selected in Selector.	Select recipe and try again.
Recipe	1020	Recipe /*S:0 Param1*/ failed. Cause: Data type of data point /*S:0 Param2*/ is incompatible with ingredient type of ingredient /*S:0 Param3*/.	Change the type of the ingredient to match the type of the data point, or select a different data point which matches the type of the ingredient.



PanelView Component Terminal Alerts

Category	ID	Description	Corrective Action
Recipe	1021	Recipe /*S:0 Param1*/ failed. Cause: Unable to read from /*S:0 Param2*/	Check the communication settings, and data point specification.
Recipe	1022	Recipe /*S:0 Param1*/ failed. Cause: Unable to read from Tag.	Check the communication settings, and data point specification.
Recipe	1023	Recipe download failed. Cause: The value /*S:0 Param1*/ is greater than the maximum value /*S:0 Param2*/ allowed for ingredient /*S:0 Param3*/	Correct the dataset value.
Recipe	1024	Recipe /*S:0 Param1*/ failed. Cause: Table does not contain a recipe.	Restore the recipe in the table before doing a save operation.
Recipe	1025	Recipe /*S:0 Param1*/ of recipe /*S:0 Param2*/ failed. Cause: · Recipe file not accessible.	Try to reload the application to see if the recipe is still there, or restore from a .cha file from your computer or SD card.
Recipe	1026	Recipe Upload Failed.	This message is for informational purposes. No corrective action needed.
Recipe	1027	Recipe operation in progress.	This message is for informational purposes. No corrective action needed.
Alert	2000	Loading.	This message is for informational purposes. No corrective action needed.
Alert	2001	Unloading.	This message is for informational purposes. No corrective action needed.
Alert	2002	Terminal is starting up...	This message is for informational purposes. No corrective action needed.
Alert	2003	Application is currently being edited, user input is disabled.	Put the application into Test or Run mode to enable user input.
Alert	2004	Copying file...	This message is for informational purposes. No corrective action needed.
Alert	2005	Deleting file...	This message is for informational purposes. No corrective action needed.
Alert	2006	Operation failed.	This message is for informational purposes. No corrective action needed.
Alert	2007	Operation succeeded.	This message is for informational purposes. No corrective action needed.
Alert	2008	Cannot run application. Application version incompatible.	Edit, validate, and then save the application with this version and try again.
Alert	2009	Cannot run application. Communication connection not supported.	Terminal does not support the communication connection configured in this application. Edit the application and configure communication for the supported connection type.
Alert	2010	This application is not validated. Are you sure you want to run a non-validated application?	If you do not want to run the invalid application, cancel the operation, then edit and validate the application. Correct all validation errors, save the application, and try again.
Alert	2011	Cannot run a modified application.	Save the application and try again.

PanelView Component Terminal Alerts

Category	ID	Description	Corrective Action
Alert	2012	Application has been modified. Continue without saving?	Edit the application and save prior to performing this operation, otherwise changes to the application may be lost.
Alert	2013	Currently loaded application has been modified. All changes will be lost by running this application. Continue?	Edit the application and save prior to performing this operation, otherwise changes to the application may be lost.
Alert	2014	Application was designed for a different terminal type and may not appear or operate as intended. Continue?	Edit the application on the terminal type that it is intended for.
Alert	2015	Application will be unloaded and deleted. Continue?	Click Yes to continue with operation.
Alert	2016	Confirm deletion?	Click Yes to delete the file.
Alert	2017	Confirm restart?	Press Yes to restart the terminal.
Alert	2018	File already exists. Overwrite?	If you do not want to overwrite the file, cancel the operation and rename the file before performing this operation.
Alert	2019	Cannot copy over loaded application. Unload application and continue with overwrite?	Click OK to unload and overwrite the application.
Alert	2020	Cannot copy over loaded application.	Unload application and try again.
Alert	2021	Insufficient space to complete file copy.	Remove files to free space from the destination and try again.
Alert	2022	Source and destination cannot be the same.	Verify the source and destination are not the same and retry.
Alert	2023	Application has been left in edit or test mode.	Reconnect the designer or press OK to proceed to the configuration screens.
Alert	2024	File not found.	
Recipe	2025	Copy failed. Only existing recipe files can be updated.	Create the recipe through the designer or rename this recipe to the existing recipe name and try again.
Recipe	2026	Copy failed. Invalid recipe file.	The imported recipe must have the same number of ingredients and data sets as the existing recipe it is replacing.
Alarm	2027	Alarm logs can only be copied from a loaded application.	Load the application into Edit, Test, or Run mode and retry.
Alert	2028	Files can only be copied to a secured application while editing the application.	The application has been secured with design rights. Load the application into Edit mode and retry.
Alert	2029	Files can only be copied from a secured application while editing the application.	The application has been secured with design rights. Load the application into Edit mode and retry.
Alert	2030	Cannot delete a loaded application.	Unload application and try again.
Alert	2031	Files can only be deleted from a secured application while editing the application.	The application has been secured with design rights. Load the application into Edit mode and retry.
Alert	2032	Return to out of box condition?	Press Yes to reboot the terminal and return to the out of box condition.
Alert	2033	Source file does not exist.	Make sure the source file exists and retry.

PanelView Component Terminal Alerts

Category	ID	Description	Corrective Action
Alert	2034	Destination folder does not exist.	Make sure the destination location exists and retry.
Alert	2035	Insufficient disk space. Please free disk space and try again.	Remove files to free space by pressing the Delete File button on the File Transfer tab.
Alert	2036	This application is not validated. Are you sure you want to run a non-validated application?	Press Yes to continue running the invalid application, or No to proceed to the configuration screens. Then, edit and validate the application. Correct all validation errors, save the application, and try again.
Alert	2038	Cannot change password because password has been marked as unmodifiable.	Edit the application and go to the Security tab. Check the Modifiable? box associated with the username and password.
Alert	2039	Cannot change password because no user is logged onto the terminal.	Log on as one of the users defined in the application and retry.
Alert	2040	Old password does not match the password for the current user.	Enter the current user's password for the Old Password.
Alert	2041	Cannot reset password, this is an unknown user.	Log on as one of the users defined in the application and retry.
Alert	2042	Cannot change password, new and confirm passwords don't match.	Verify the new password matches the confirmed password and retry.
Alert	2043	Access Denied	The username/password is either incorrect or the user does not have the access right for the associated screen.
Alert	2044	Cannot run application while in Safe mode.	Reboot the terminal to exit Safe mode and retry.
Alert	2045	Cannot run applications from external storage.	Copy or save to internal storage and try again.
Alert	2046	Passwords cannot be modified while in test mode.	The change password and reset password devices are only enabled while in Run mode.
Alert	2047	File is read-only. Continue?	Choosing to continue will overwrite the read only file.
Alert	2048	Application has been modified. Continue?	Edit the application and save prior to performing this operation, otherwise changes to the application may be lost.
Alert	2050	The value is not within the minimum and maximum range.	Enter a value within the allowable range. If you do not know the range Edit the application to determine the allowable range for the device.
Alert	2051	Allow Autorun?	Press No to disallow Autorun.
Alert	2052	Application has been modified. Allow Autorun?	Press No to disallow Autorun. Edit the application and save prior to performing this operation, otherwise changes to the application may be lost.
Alert	2053	Screen switching controlled by external source.	Screen navigation devices are disabled if the screen has been changed to via controller.
Alert	2054	Cannot reset the terminal in Safe mode.	Terminal reboot is disabled on the emulator. Select Flash>Save and then select File>Reset>Hard to reboot the emulator.
Alert	2055	Image exceeds maximum resolution of 800x800.	Open file in image editor and reduce the resolution.

PanelView Component Terminal Alerts

Category	ID	Description	Corrective Action
Alert	2056	Cannot copy recipe to a loaded application.	Please unload application and try again.
Alert	2057	Terminal is running low on application memory (<Available_Virtual_Memory>bytes).	Please reset the terminal or this may lead to fatal error.
Alert	2058	Failed setting property: /*S:0 Param1*/:/*S:0 Param2*/, value = /*S:0 Param3*/	Verify the range of the numeric display that uses the external tag as its write tag is within the range of a tag (validation should provide a warning if the range of the tag is greater than the range of a numeric entry). Make sure that the values of the state based objects that write to an external tag are within the range of the tag. Make sure that the value that written to an external tag matches the tag type (for example, do not write a non-numeric string into a numeric tag).
Alert	2059	Failed setting property (/*S:0 Param1*/): /*S:0 Param2*/:/*S:0 Param3*/, value = /*S:0 Param4*/	Verify the range of the numeric display that uses the external tag as its write tag is within the range of a tag (validation should provide a warning if the range of the tag is greater than the range of a numeric entry). Make sure that the values of the state based objects that write to an external tag are within the range of the tag. Make sure that the value that written to an external tag matches the tag type (for example, do not write a non-numeric string into a numeric tag).
Alert	2060	Terminal is running low on RAM (<Available_RAM>bytes).	Please reset the terminal or this may lead to fatal error.
Alert	2061	Out of memory: Terminal cannot continue to run and will be reset.	This is a out of memory critical message. Dismissing this dialog causes the terminal to reset. After the terminal resets, try to edit an application and reduce its size by removing some objects, for example, user controls, screens, tags, or alarms.
Alert	2055 *	Cannot copy recipe to a loaded application.	Please unload application and try again.
Alert	3001	Available memory is too low to run the application.	Please try to release some memory or this may lead to fatal error.
Multilanguage	8193	Language switch ignored. Application was not configured with new language. An attempt was made to switch to a language that is not configured for this application.	Either add the specified language and associated strings or remove the unconfigured language selection.



Troubleshooting

If your terminal does not start up correctly, check for adequate power, observe the splash screen state message and status code, indicator states, or an application that is not running during powerup.

Determine what changed since the last time the terminal ran normally and decide if the change can be reversed.

Check for Adequate Power

A terminal that does not receive adequate power could cause unpredictable behavior. Verify the power requirements in the Specifications table.

Observe Splash Screen

Various actions and status conditions of the terminal are reported on the splash screen, including version information about the hardware and firmware.

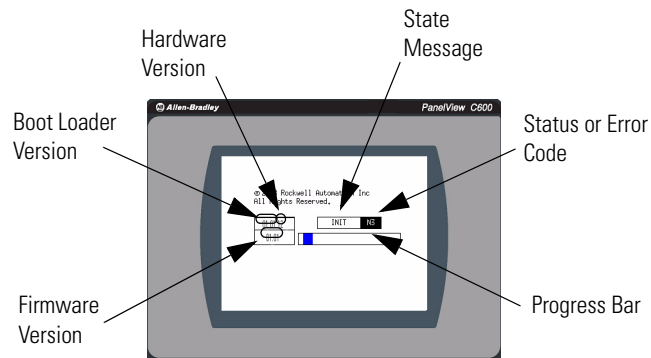

These tables describe the state messages and the status or error codes that appear on the splash screen.

Power-on Self-test (POST) Failures

Message	State	Code
POST Failed RAM	Fatal	6C
POST Stuck Key	Fatal	31
POST Stuck Touch	Fatal	3A

Firmware Installation and Loading

Message	State	Code
Load Firmware Image into RAM	Update	1E
Write Firmware Image into Flash	Update	A5
Complete and Successful Firmware Installation	Update	OK

Firmware Installation and Loading

Message	State	Code
Firmware Image Validation (CRC/Format) Failure	Fatal	1E
Firmware Image Compatibility Failure	Fatal	1F
Firmware Write to Flash error	Fatal	A5
Firmware Read-After-Write Verify	Fatal	D2
Invalid or missing Firmware Image	Fatal	0A

Other Commonly Observed Status Codes

Message	State	Code
Boot Loader connects to PC via USB Device	AutoTest	0A
Boot Loader loads Firmware Image into RAM	AutoTest	E6
Boot Loader jumps to Operating System	AutoTest	FF
Operating System start up	Boot	G0
Operating System Initialize	Init	I1...J0
Application Registration and Initialize	Init	N1...N3
Application Load and Execute	Load	N4...N6

POST errors are fatal and most likely due to failed hardware. A fatal error during firmware installation and loading is most likely recoverable by installing the appropriate firmware.

Interpret the Status Indicators at Startup

The C400 terminal has a Power indicator on the front of the unit to identify the system status. The table shows system indicator status.

System Status LED Indicator

LED Indicator	Description
Green	System is running and display is switched on.
Red	System is running and display is in screen saver mode.

The C400, C600 and C1000 terminals have indicators on the back of the unit to isolate operating problems.

- Comm indicator for communication
- Fault indicator for hardware faults

At startup, the Fault indicator is off, except for a few brief flashes, and the Comm indicator is on. If the indicators remain off, check the power cable. After a successful startup, both indicators are off and controlled by the application running on the terminal.

The table shows indicator states if the terminal stops during startup.

Fault Indicator States During Startup

Fault (Red) Indicator State	Comm (Green) Indicator State	Description	Recommended Action
Potentially recoverable errors			
Blinking	Off	Last firmware download failed.	Reload the firmware.
Blinking	Blinking	EBC boot loader firmware failed or is missing.	Reload the firmware.
Blinking	On	Windows CE OS firmware failed or is missing.	Reload the firmware.
Nonrecoverable or fatal errors			
On	Off	Fatal hardware error.	Replace the terminal.
On	Blinking	Fatal display hardware error.	Replace the terminal.

Returning to the Out-of-box Condition

You may want to return a terminal to the out-of-box condition to refresh the terminal or to recover from severe application misbehavior. There is a special maintenance action that permits you to perform a complete reset and return to the out-of-box condition for the terminal.

Returning a terminal to an out-of-box condition does not affect the terminal firmware version or the installed font image.

Follow these steps to return your terminal to the out-of-box condition.

1. Connect an external USB keyboard to the terminal and hold the Ctrl and Shift keys simultaneously, while starting up the terminal.

A dialog box appears with the prompt:
Return to Out of Box Condition?

IMPORTANT

Keyboards initialize at different times. If the terminal boots normally to the configuration screen or the selected startup application, the keyboard press was not recognized.

Restart the terminal and wait until the boot screen displays the INIT code N1, then press and hold the Ctrl and Shift keys until the dialog box appears.

2. Press Yes or F1 to return to the out-of-box condition, or press No or F2 to cancel.

If you choose to return to the out-of-box condition, the terminal resets. On the subsequent boot, the file system is formatted and removes the contents including applications, logs, recipes, user-installed fonts, objects, and graphics. Most terminal configuration parameters are returned to their default values.

IMPORTANT Returning to the out-of-box condition does not change the current firmware on your terminal. If you upgraded the firmware on your terminal, the upgraded firmware version remains unaffected. Refer to [page 76](#) for details on what is included in a firmware upgrade.

IMPORTANT If you set the terminal security and forgot your password, you can use this procedure to restore your terminal. Remember, it will remove all applications, logs, recipes, user-installed font files, objects, and graphics.



Notes:

Specifications

General Specifications

PanelView Component - 2711C-F2M, 2711C-K2M, 2711C-T3M, 2711C-K3M, 2711C-T4T, 2711C-T6M, 2711C-T6C, 2711C-T6T, 2711C-T10C

Attribute	Value
Display type C200 C300 C400 C600 C1000	Monochrome transfective STN passive matrix Monochrome transfective FSTN passive matrix Color transmissive TFT active matrix LCD Monochrome transmissive FSTN passive matrix or Color transmissive CSTN passive matrix or Color transmissive TFT active matrix LCD Color transmissive TFT active matrix LCD
Display size C200 C300 C400 C600 C1000	2 in. 3 in. 4 in. 5.7 in. 10.4 in.
Display area C200 C300 C400 C600 C1000	49 x 14 mm (1.93 x 0.55 in.) 67 x 33 mm (2.64 x 1.30 in.) 95.04 x 53.856 mm (3.742 x 2.12 in.) 115 x 86 mm (4.53 x 3.39 in.) 211 x 158 mm (8.31 x 6.22 in.)
Resolution (pixels) C200 C300 C400 C600 C1000	122 x 32 128 x 64 480 x 272 320 x 240 640 x 480
Backlight C200 C300 C600 and C1000 C400 and C600 (2711C-T6T)	50,000 hours life, min., backlight not replaceable Yellow/Green status indicator White status indicator CCFL 40,000 hours life, min., backlight not replaceable White LED
Operator input C200 C300 C400 C600 and C1000	Function keys or combination function keys and numeric keypad Analog touch or combination function keys and numeric keypad Analog touch and function keys Analog touch



PanelView Component - 2711C-F2M, 2711C-K2M, 2711C-T3M, 2711C-K3M, 2711C-T4T, 2711C-T6M, 2711C-T6C, 2711C-T6T, 2711C-T10C

Attribute	Value
Memory card C200, C300, and C400 C600 and C1000	USB port USB port and Secure digital (SD) card
Programming port	USB device port
Battery life	5 years min at 25 °C (77 °F)
Real-time clock C200 and C300 C400, C600, and C1000	No battery backup Battery backup
Input voltage range	18...30V DC (24V DC nom)
Power consumption, max C200 and C300 C400 C600 C1000	5 W (0.21 A at 24V DC) 7 W (0.28 A at 24V DC) 10 W (0.42 A at 24V DC) 18 W (0.75 A at 24V DC)
Weight, approx. C200 function key C200 keypad, C300 keypad C300 touch C400 touch C600 touch C1000 touch	0.19 kg (0.40 lb) 0.30 kg (0.65 lb) 0.20 kg (0.43 lb) 0.347 kg (0.76 lb) 0.68 kg (1.48 lb) 1.57 kg (3.41 lb)
Dimensions (HxWxD), approx. C200 function key C300 touch C200 keypad, C300 keypad C400 touch C600 touch C1000 touch	80 x 116 x 54 mm (3.15 x 4.54 x 2.13 in.) 80 x 116 x 57 mm (3.15 x 4.54 x 2.23 in.) 119 x 139 x 55 mm (4.69 x 5.47 x 2.15 in.) 113 x 138 x 43 mm (4.45 x 5.43 x 1.69 in.) 154 x 209 x 57 mm (6.0 x 8.23 x 2.25 in.) 250 x 308 x 54 mm (9.84 x 12.13 x 2.13 in.)

Environmental

Attribute	Value
Temperature, operating	0...50 °C (32...122 °F)
Temperature, nonoperating	-25...70 °C (13...158 °F)
Heat dissipation C200 and C300 C400 C600 C1000	16 BTU/hr 24 BTU/hr 32 BTU/hr 58 BTU/hr
Relative humidity	0...95% noncondensing
Shock, operating	15 g at 11 ms
Shock, nonoperating	30 g at 11 ms
Vibration	2 g at 10...500 Hz
Enclosure type ratings	NEMA/UL Type 4X (indoor) 12, 13, and IEC IP54, IP65 2711C-T6M, 2711C-T6C Series B only: NEMA/UL Type 12, 13, and IEC IP54

Certifications

Certifications (when product is marked) ⁽¹⁾	Value
c-UL-us	UL Listed Industrial Control Equipment, certified for US and Canada. See UL File E113724. UL Listed for Class I, Division 2 Group A,B,C,D Hazardous Locations, certified for U.S. and Canada. See UL File E10314.
CE	European Union 2004/108/EC EMC Directive, compliant with: EN 61000-6-2; Industrial Immunity EN 61000-6-4; Industrial Emissions
C-Tick	Australian Radiocommunications Act, compliant with: AS/NZS CISPR 11; Industrial Emissions
KC	Korean Registration of Broadcasting and Communications Equipment, compliant with: Article 58-2 of Radio Waves Act, Clause 3

⁽¹⁾ See the Product Certification link at <http://ab.com> for Declarations of Conformity, Certificates, and other certification details.

Notes:

Adding Font Files

Available Fonts

These fonts reside on the terminal in the firmware image.

- Arial
- Courier New
- Tahoma
- Asian Font (Simsun - Simplified Chinese)

You can change the Asian Font firmware image from Chinese to Korean, or Korean to Chinese, by using the firmware upgrade method described in Chapter 5. The Arial, Courier and Tahoma fonts cannot be altered.

Additional Windows CE licensed fonts can be added to the terminal. Windows CE licensed fonts can be downloaded from the PanelView Component Tech Support website. No other fonts are licensed for use on the terminal.

Set up Fonts for PanelView Component DesignStation 2.0

Ensure that you install a .NET framework before setting up fonts.

Copy the fonts files to this folder c:\Program Files\Allen-Bradley\PanelView Component DesignStation\Fonts. Launch PVcDesignStation 2.0 to finish setting up the fonts.

IMPORTANT Additional fonts can not be imported into PanelView Component DesignStation 3.0. Only the existing system fonts can be used.

Import a Font File

You can import a Microsoft Windows CE font to your terminal. Other font files are not supported.

During the import, the font file is transferred from a USB Flash Drive or SD card to the internal storage of the terminal. The transfer operation communicates with the terminal to transfer the file.

You can use the imported font in any application on the terminal.

TIP Fonts cannot be exported for copyright reasons.

Follow these steps to add a font to the terminal.

1. Open the PanelView Explorer Startup window.

2. Click File Transfer.
3. Click New Transfer.
4. Select the source location of the Font file, typically My Computer, and click Next.
5. Select Font as the file type and click Next.
6. Click Browse ... to locate and select the Font file, then click Open.
7. Select Internal Storage as the destination for the font file and click Transfer.
8. Observe the informational message for Transferring File.
9. The terminal should be rebooted to load the added font and make it available to the design environment.



ATTENTION: If importing a font to the emulator internal storage, you need to Flash Save for it to be permanently stored in the emulator. Otherwise, it will be lost once you shut down. To save to internal storage, select Flash and then Save from the Emulator main window menu.

Remove a Font File

A font that was added to the terminal and is no longer used can be removed. Follow these steps to remove a font from the terminal.

1. Open the PanelView Explorer Startup window.
2. Click File Transfer.
3. Click Delete File.
4. Select the source location of the Font file, typically Internal Storage, and click Next.
5. Select Font as the file type and click Next.

Observe the list of all Font files that have been added to the Terminal.
6. Select the Font file that you want to delete and click Delete.
7. Observe the Confirmation message for the selected Font file and click OK.
8. Observe the informational message Deleting File.

9. Observe the deleted font file no longer appears in the list of all Font files.
10. Reboot the terminal to remove the file from the design environment.



ATTENTION: If deleting a font from the emulator internal storage, you need to Flash Save for it to be permanently stored in emulator. Otherwise, it will be lost once you shut down. To save to internal storage, select Flash and then Save from the emulator's main window menu.

TIP

Font files, especially East Asian Fonts, are large and consume significant space on Internal Storage. Remove all unused fonts from the terminal.



Notes:

PanelView Component Emulator

Overview

The PanelView Component terminal emulator is treated as a terminal and runs almost the exact same firmware. The emulator has its own file system. One folder of the file system (PC Storage) can be mapped to a folder in your computer's file system. Anything stored in the mapped folder can be accessed by both the emulator and your computer.

By default on the emulator, applications are saved to the mapped folder (PC Storage).

Install the Emulator

The PanelView Component Emulator can be installed on computers running Windows XP (SP2) or Windows Vista. For better emulator performance, your computer should have at least an Intel Pentium M 1400 MHz processor, with 512MB RAM.

Your computer information can be found by right-clicking on My Computer and selecting properties.

The PanelView Component Emulator Installer installs the following five components. If you select Full Install, all five of these components are installed. If you select Custom Install, you have the option of selecting which of these components are installed.

- Microsoft Device Emulator
- Microsoft Virtual PC
- Microsoft Loopback adapter
- PanelView Component Emulator
- Extended support files - fonts, demos, graphics, help



Follow these steps to install the emulator components.

1. Go to <http://ab.rockwellautomation.com/Graphic-Terminals/2711C-PanelView-Component-C400-Terminals> to download the emulator components.
2. Run the PVc Emulator executable file.
The InstallShield Wizard appears.

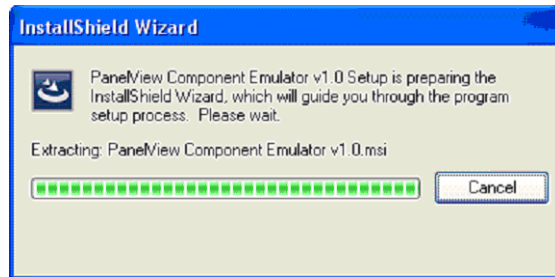

The initial splash screen announces that the installer is running. It identifies the product being installed.

3. Click Next to continue the installation or Cancel to cancel installation.

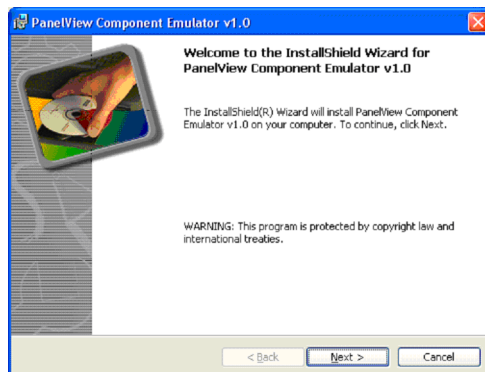

4. Accept the license agreement and click Next to continue with the emulator installation.



5. Select the installation type.

You can select between Complete, Express, or Custom installation. Complete installs all components, at the default installation locations, and with all default user options. Custom causes the installer to bring up a dialog that allows you to customize the installation process. Express only installs the PanelView Component Emulator. Use Express install for upgrading the firmware of the emulator.

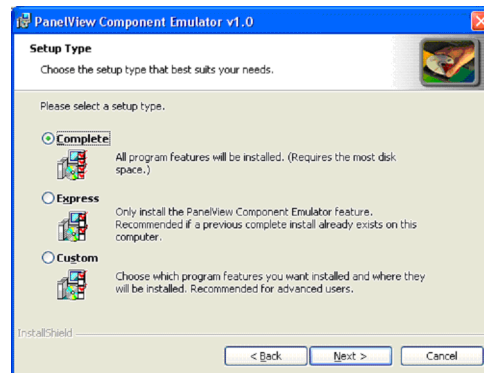

6. If you selected custom setup you to select individual components to install, select install paths (where appropriate), and select install options (where appropriate).

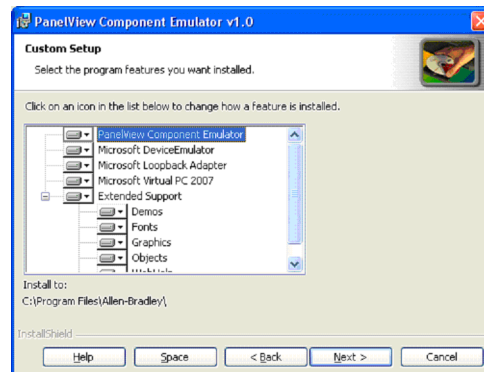

7. Click Install to continue with the installation, cancel to cancel the process, or back to make changes to your installation.

The verification screen gives you a chance to cancel the installation process before any permanent changes occur.

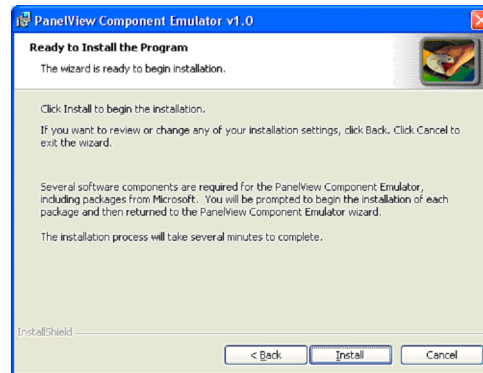

The progress screen gives you a visual indication of the installation progress.

IMPORTANT

The Microsoft Device Emulator and Microsoft Virtual PC have their own installation procedure and agreements. Once they are installed (if you selected complete install or selected them for custom install) you will be brought back to the finish dialog.

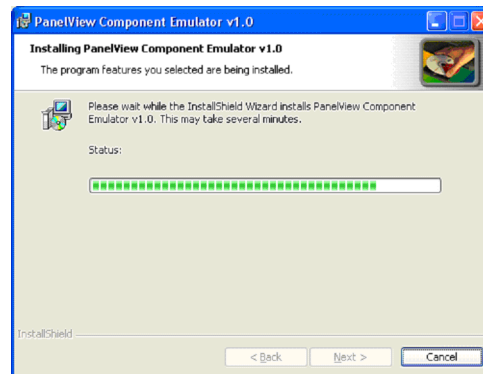

8. Click Finish to complete the installation.

The install complete screen is the final confirmation that the install has completed successfully. It should be displayed only after all selected components have completed installation.

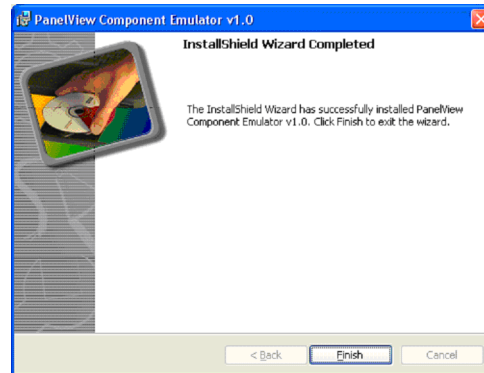

PanelView Component Extended Support

This is a Rockwell Automation provided accessory for the PanelView Component emulator. This component consists of extended help files, sample applications, libraries, and font files. These files were originally installed in the Mapped Share folder. Note, multiple versions of the PanelView Component Emulator could be using the same Mapped Share folder.

During uninstallation of the PanelView Component Emulator, a check is made to see if the Mapped Share folder is being used by any other versions of the emulator. If other versions are using the same Mapped Share folder, this step is skipped entirely. If the PanelView Component Emulator version being uninstalled is the only version using this Mapped Share folder, the uninstaller will ask if you want to remove the extended support files. If you select Yes, the files are deleted and the Mapped Share folder is removed. If you select No, this step is skipped and the files and directory remain.

Errors During Installation

If an error is reported while configuring the Loopback Adapter, make sure the Loopback Adapter settings are correct.

Follow these steps to configure the Loopback Adapter settings.

1. Open the Windows Network Connections folder and right-click the connection with device name Microsoft Loopback Adapter.

Name	Type	Status	Device Name
LAN or High-Speed Internet			
Local Area Connection	LAN or High-Speed Internet	Connected	Broadcom NetXtreme 57xx Gigabit Controller
Local Area Connection 40	LAN or High-Speed Internet	Connected	Microsoft Loopback Adapter
Wireless Network Connection	LAN or High-Speed Internet	Disabled	Dell Wireless 1390 WLAN Mini-Card
1394 Connection	LAN or High-Speed Internet	Disabled	1394 Net Adapter

2. Select Properties.
3. Make sure the Internet Protocol (TCP/IP) box is checked, highlight Internet Protocol (TCP/IP) and select Properties.

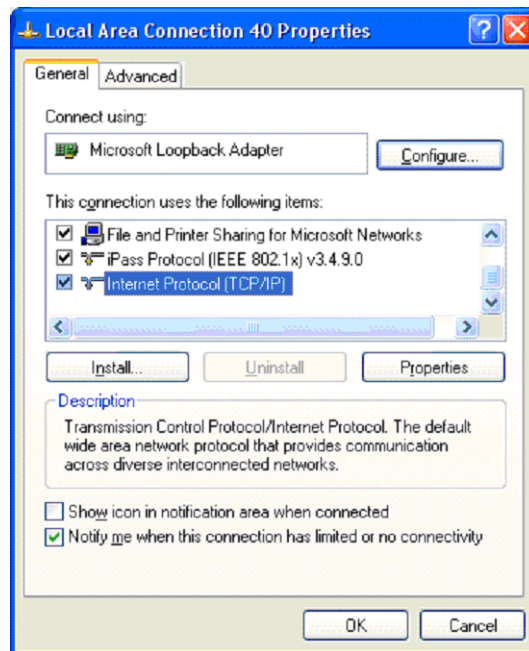

4. Verify that this IP address and Subnet Mask are set.

IP address: 169.254.253.15
 Subnet mask: 255.255.255.0

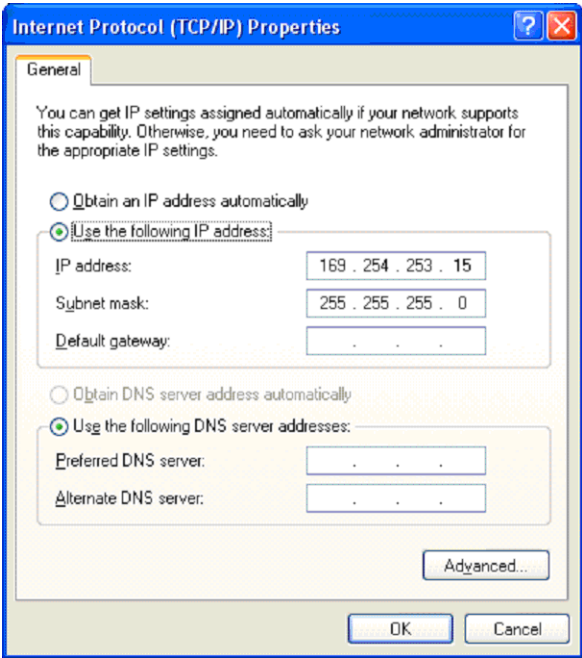

Uninstall the Emulator

The PanelView Component Emulator, Microsoft device emulator, and Virtual PC programs are listed as separate items in the Windows Add or Remove Programs list. If you have multiple versions of the PanelView Component emulator, you can remove whichever version you want. The Microsoft device emulator and Virtual PC programs are still needed by the PanelView Component emulators that remain installed. The PanelView Component uninstaller will not uninstall those components because they may be used by other software packages. You are required to uninstall them separately if desired.

The PanelView Component uninstaller removes all registry settings, files, directories, and Windows Start menu items that were originally installed with this component (for more information, see [PanelView Component Extended Support](#)).

Follow these steps to uninstall the emulator components.

1. Go to the Control Panel under the Windows Start Menu.
2. Select Add or Remove Programs and highlight PanelView Component Emulator v1.x.

Multiple versions of the PanelView Component Emulator can reside on the same computer.

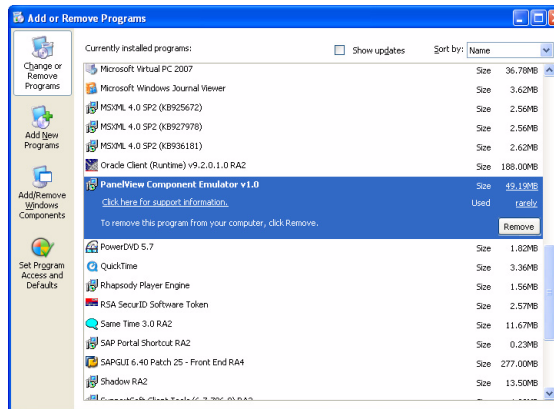

3. Click Remove.
4. Click Yes to confirm that you want to remove the PanelView Component Emulator.

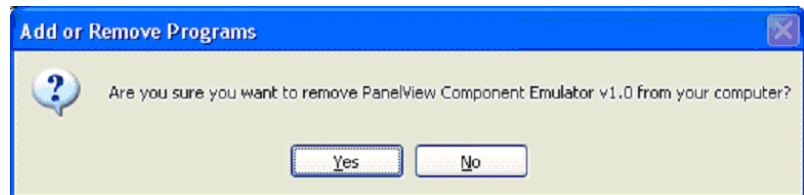

The computer goes through the removal process and shows a progress screen.

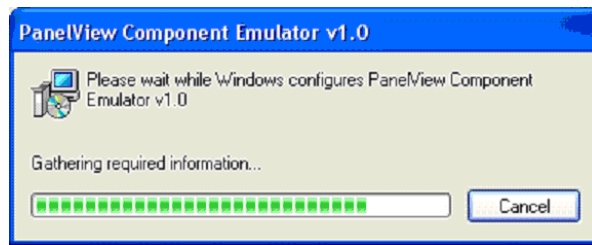

After the last version of PanelView Component Emulator is uninstalled, you are asked if you want the mapped share folder removed.

5. Click Yes or No on the Remove Share folder dialog.

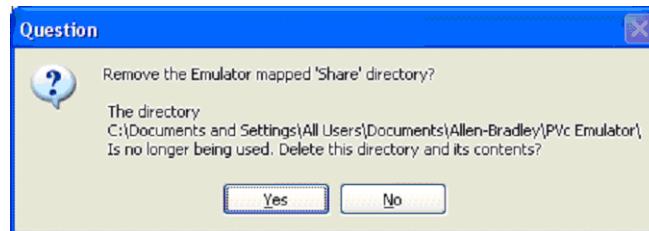

TIP Make note of this directory location if you plan to reinstall the emulator at a later date. If you choose this same Share directory when reinstalling the emulator all your current files will be automatically available.

If you answer yes, the folder and all its contents are deleted. If you wish to preserve its contents, answer no.

TIP By default, the application files you create are stored in this folder. If you wish to preserve the applications that you created, answer no for the folder to remain on the computer.

6. Follow the uninstall process for the Microsoft Device Emulator, Microsoft Loopback Adapter, and Virtual PC files from your computer if necessary.

IMPORTANT The Microsoft Device Emulator, Microsoft Loopback Adapter, and Virtual PC could be used by other software packages.

Directory Layout and Content

This section describes where you can find the files that the installer loaded on your computer.

Device Emulator Component

The directory layout for the Device Emulator is defined by the Microsoft installer for this component. No additional actions are required by the PanelView Component Emulator Installer.

The only emulator main menu item you may need to use is Flash Save. Select Flash Save to preserve settings for the next time the emulator is started such as after copying fonts or User Defined Objects into the emulator. The other menu items on the main menu do not apply to the PanelView Component emulator.

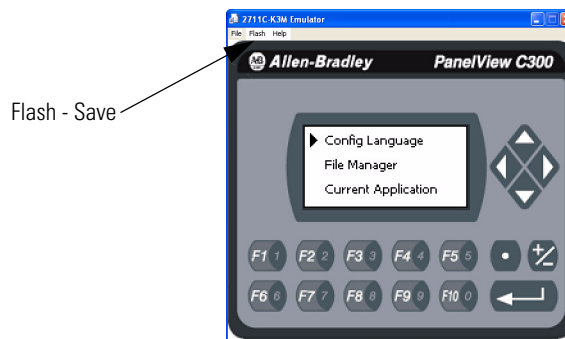

Virtual PC Component

The directory layout for the Virtual PC is defined by the Microsoft installer for this component. No additional actions are required by the PanelView Component Emulator Installer.

PanelView Component Emulator Component

The root install location for the PanelView Component Emulator component is C:\Program Files\Allen-Bradley. The directory structure under the root location is shown.

Root Location Directory Structure

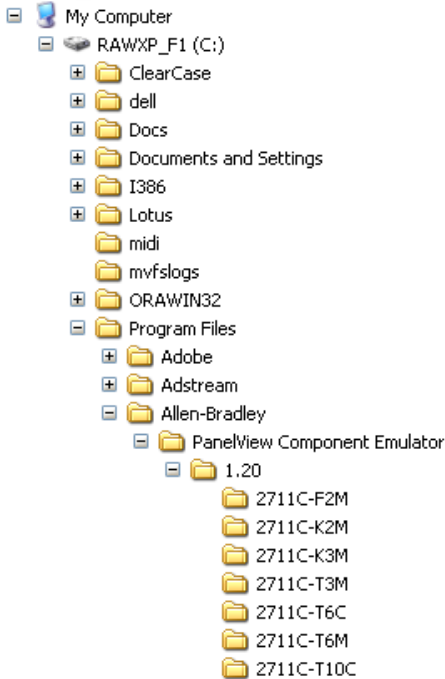

The install directory under the root is named PanelView Component Emulator. This folder contains the script files required for launching the emulator.

Under the PanelView Component Emulator directory is the directory named #.#.# (where #.#.# is the major and minor version number of the emulator). This format allows later versions of the emulator to be installed without disrupting previous installations.

Emulator Versions

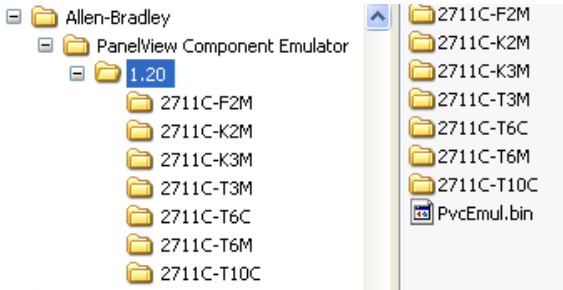

There is a subdirectory for each terminal type. The subdirectory name is the catalog number for the respective terminal type. These subdirectories contain the files that define each emulated terminal image and behavior. The files making up the emulator contain the base name of the terminal catalog.

Terminal Subdirectory

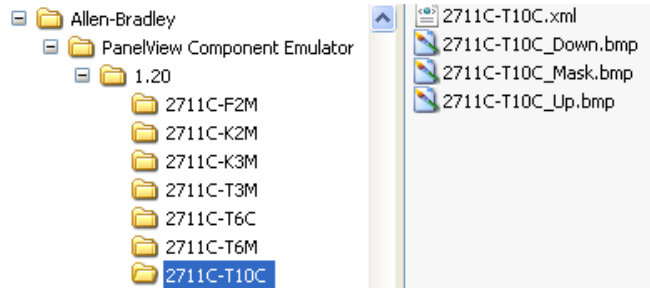

Mapped Share Folder

The emulator is launched with the command line option that maps a PC folder into the emulator's file system. The given computer folder is referred to as the Mapped Share folder. The default location for this mapped share folder is shown.

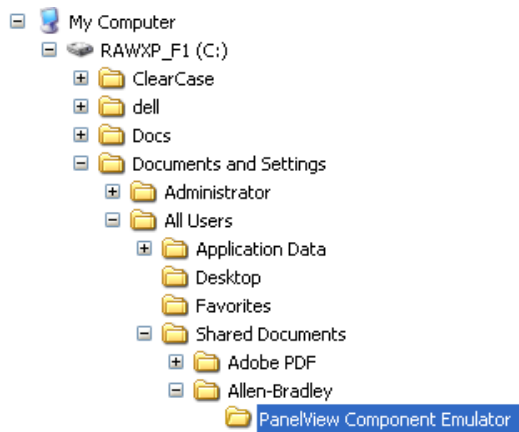

However the installer allows the user to optionally select a different location for this shared folder.

Launch Mechanism

There are two primary ways to launch the PanelView Component emulator. The first is via entries in the Windows Start Menu. The second is via double-clicking a PanelView Component user application file (*.cha).

Windows Start Menu

The PanelView Component Emulator installer creates entries in the Windows Start Menu that can be used to launch a specific emulated terminal type. There is also a shortcut named Applications which is simply a shortcut to the Mapped Share folder. The shortcuts are installed for all users.

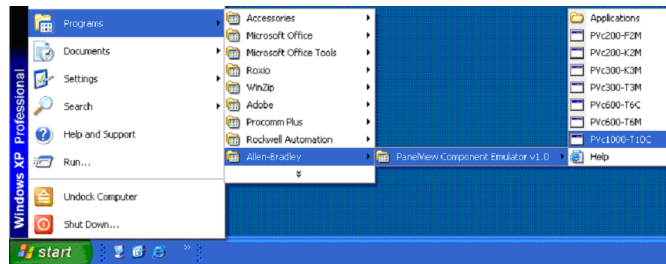

Using the Emulator

The emulator lets you create applications without being connected to a terminal. By default anytime you create/save an application on emulator, it goes to the mapped share folder.

TIP When using the emulator to create or change applications, make sure your pop-up blocker is off.

Anything you pull into internal storage on the emulator (fonts, graphics) has to be Flash Saved for it to be permanently stored in emulator. Otherwise, it's lost once you shut down. To save to internal storage, select Flash and then Save from the Emulator's main window menu.

On the emulator do not change terminal communication settings, otherwise you need to uninstall and install the emulator and the data will be lost.

Follow defaults when installing the emulator, it sets up the file structure.

TIP For more information on working with the emulator, refer to the context-sensitive help.

IP addresses for your emulator

The following is a list of IP addresses to use with your emulator.

IP Addresses for Emulators

Terminal Catalog Number	IP Address
2711C-T10C	169.254.253.9
2711C-T6T	169.254.253.10
2711C-T4T	169.254.253.11
2711C-T6M	169.254.253.8
2711C-T6C	169.254.253.7
2711C-T3M	169.254.253.6
2711C-K3M	169.254.253.5
2711C-K2M	169.254.253.4
2711C-F2M	169.254.253.3

Error Codes

There are a variety of failure conditions that can occur in the emulator/browser launch process. The launch mechanism contains a popup dialog to report errors to the user. To avoid multi-language issues, the error reporting dialog simply contains a title bar and up to three pieces of error detail information. The first piece of this error detail information is required. This is the error code. The remaining two pieces are optional and their content varies according to the error code.

PVcEmClick Error Codes

Code	Parameter 1	Parameter 2	Description
0x10001	0	<cmd args>	Invalid command line
0x10002	0		Missing CHA file name/path command argument
	1	<name/path>	CHA file name/path argument ends in a \
	2	<name/path>	CHA file name/path does not contain path info
0x10003	0	<keyname>	Emulator info not found registry
0x10005	0	<err code>	Error reading CHA file header
	1	<cha param>	Invalid CHA file header content
0x1000A			Failed calling launch script

PVcEmLaunch Error Codes

Code	Parameter 1	Parameter 2	Description
0x20001	0	<cmd args>	Invalid command line
0x20003	0	<keyname>	Emulator root not found registry
	1	<keyname>	No matching emulator version found in registry
0x20004	0	<version>	Best fit, invalid version number format
	1	<err code>	Best fit, failed enumerating installed versions
	2		Best fit, no best fit found
0x20006	0	<xml name>	No TitleBar found in emulator skin XML file
0x20007			The emulator is already running
0x20008	0	<err code>	Unable to enumerate emulator registry parameters
0x20009	0	<keyname>	Base emulator command string not found in registry
	1		Error constructing emulator command string
	2	<keyname>	Base web browser command string not found in registry
	3		Error constructing web browser command string

PVcEmLaunch Error Codes

Code	Parameter 1	Parameter 2	Description
0x2000B			Failed launching the emulator
0x2000C			Emulator failed to start (timeout)
0x2000D			Failed launching web browser

PanelView Component DesignStation

Overview

PanelView Component DesignStation 2.0

PanelView Component DesignStation 2.0 is an offline programming software for PanelView Component. PVC DesignStation 2.0 provides a significantly faster design experience compared to developing applications online with a terminal or an Emulator. Applications developed using PVC DesignStation 2.0 can only run on terminals with Firmware Version 1.50 or later.

PanelView Component DesignStation 3.0

PVC DesignStation v3.00 is an offline windows application for designing and managing PanelView Component HMI applications.

Applications created using the PVC DesignStation can be transferred to the target PanelView Component terminals using a USB flash drive or SD storage card. You can develop applications using the PVC DesignStation, however, you can only actively run applications on a physical terminal with Firmware Version 1.70 or later

About PanelView Component DesignStation 2.0

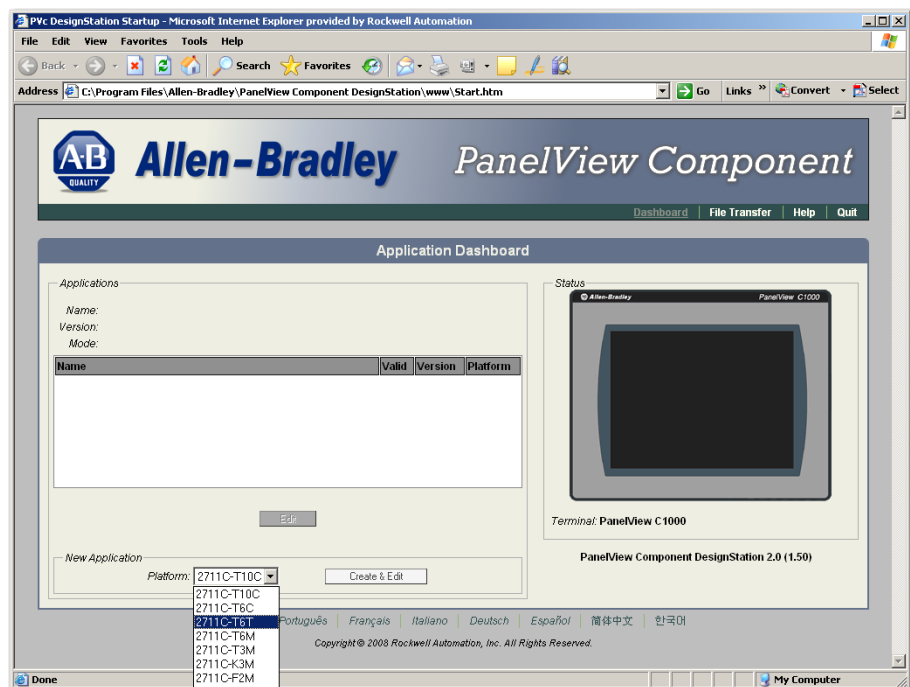

In PanelView Component DesignStation, the following features are not yet implemented:

- validation
- test mode
- run mode.

PanelView Component DesignStation only supports Internet Explorer 7 and 8. No other Internet browsers are supported at this time.

About PanelView Component DesignStation 3.0

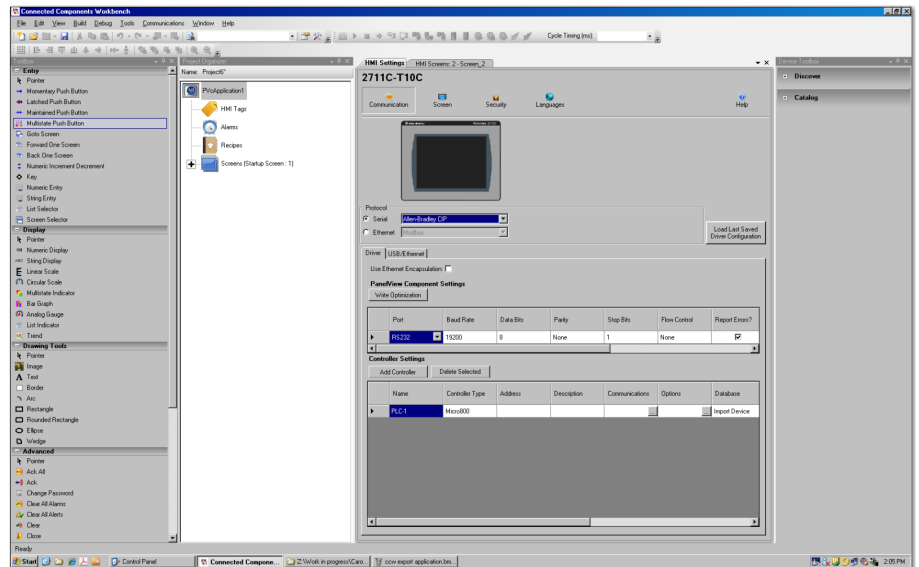

In PanelView Component DesignStation, the following features are not yet implemented:

- validation
- test mode
- run mode

PanelView Component DesignStation in Connected Components Workbench

PVc DesignStation can be launched from within Connected Components Workbench™ and runs as a tab window.

You can develop PVc applications from within Connected Components Workbench but you can only run the application on a physical terminal. PVc applications created from within Connected Components Workbench can be transferred to the target PanelView Component terminals using a USB flash or SD storage card.

We strongly recommend that you validate the transferred application using the terminal software before running the application. Non-validated applications, when started on the terminal, display a reminder pop-up message that the application is not validated.

PVc DesignStation can only have one instance running on the computer at any one time.

You can download the latest version of Connected Components Workbench for your Micro800 at the URL below.

<http://ab.rockwellautomation.com/Programmable-Controllers/Connected-Components-Workbench-Software>.

Install the Software

PanelView Component DesignStation can be installed on computers running the following:

System Requirements

PanelView Component DesignStation 2.0	PanelView Component DesignStation 3.0
Windows XP (SP3 only)	Windows XP 32 bit (SP3 only)
Windows Vista	Windows Vista 32 bit or 64 bit
Windows 7	Windows 7 32 bit or 64 bit

For better performance, your computer should have at least an Intel Pentium M 1400 MHz processor, with 512MB RAM.

Ensure that you install .NET framework 3.5 before installing the software.

Your computer information can be found by right-clicking My Computer and then selecting properties.

Follow these steps to install the software components.

TIP The following installation is for the PVc DesignStation 3.0. However, the steps involved are the same for both PVc DesignStation 2.0 and 3.0.

1. Go to <http://ab.rockwellautomation.com/Graphic-Terminals/2711C-PanelView-Component-Terminals>. to download the software components.
2. Run the executable file.

The initial splash screen announces that the installer is running. It identifies the product being installed.

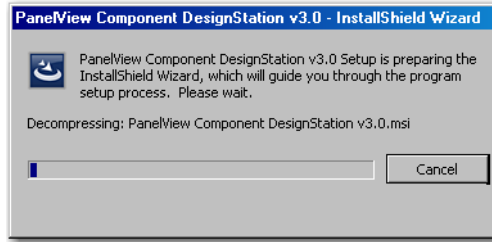

3. Click Next to continue the installation or Cancel to cancel installation.

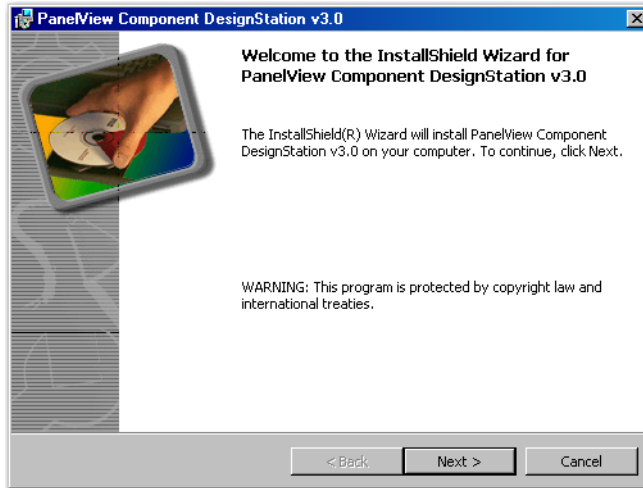

4. Accept the license agreement and click Next to continue with the installation.

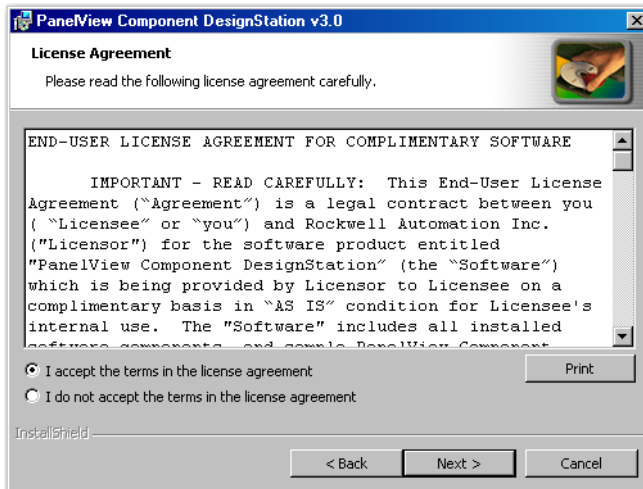

5. Click Install to continue with the installation, Cancel to cancel the installation, or Back to go back to the previous dialog.

The verification screen gives you a chance to cancel the installation process before any permanent changes occur.

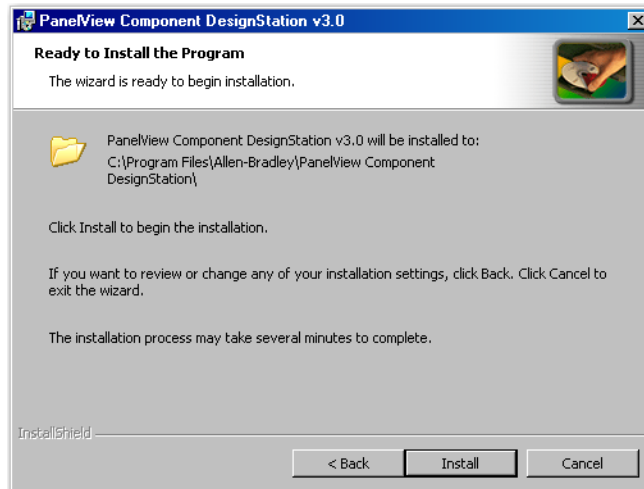

The progress screen gives you a visual indication of the installation progress.

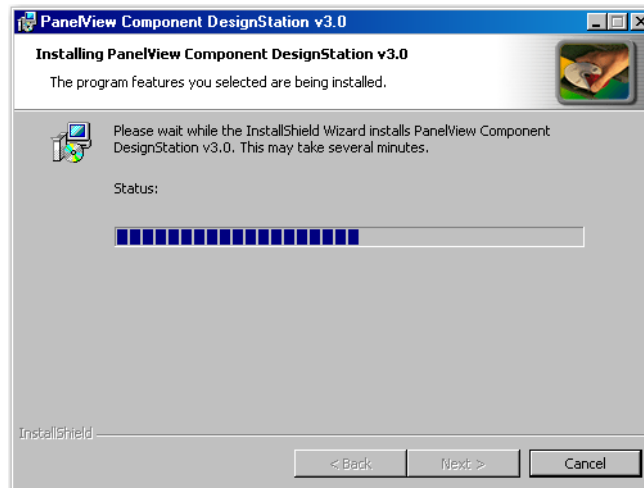

6. Click Finish to complete the installation.

The install complete screen is the final confirmation that the install has completed successfully.

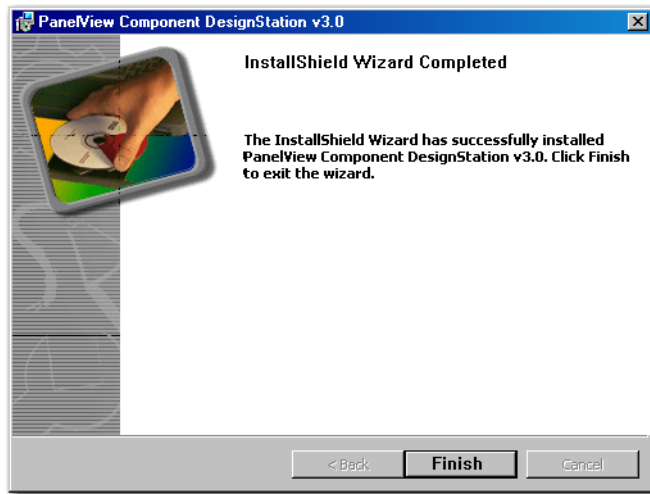

Uninstall the Software

The PVC DesignStation Software removes all registry settings, files, directories, and Windows Start menu items that were originally installed with this component .

Follow these steps to uninstall the components.

1. Go to the Control Panel under the Windows Start Menu.
2. Select Add or Remove Programs and highlight PanelView Component DesignStation.

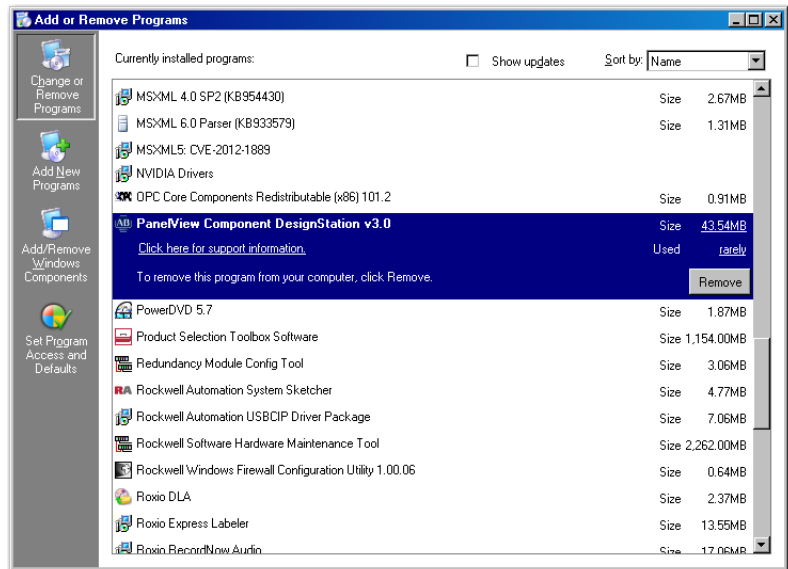

3. Click Remove.
4. Click Yes to confirm that you want to remove the software

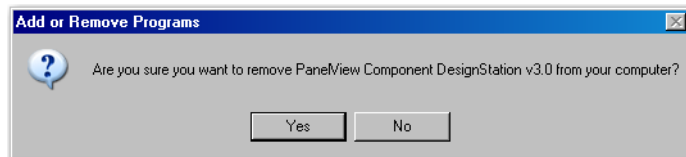

The computer goes through the removal process and shows a progress screen.

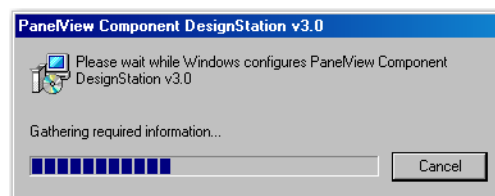

Directory Layout and Content

This section describes where you can find the files that the installer loaded on your computer.

PanelView Component DesignStation Component

The root install location for the PanelView Component DesignStation component is C:\Program Files\Allen-Bradley. The directory structure under the root location is shown.

Root Location Directory Structure

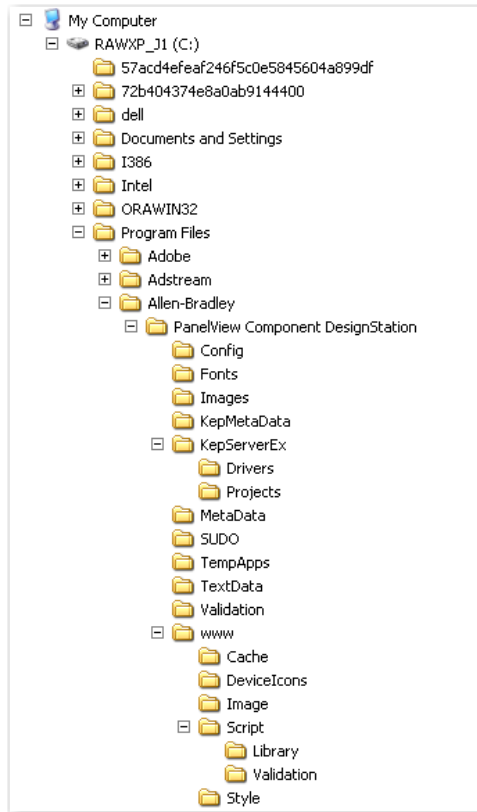

The install directory under the root is named PanelView Component DesignStation. This folder contains the files required for launching the software.

Launch Mechanism

Launch PanelView Component DesignStation via the Launch PVC DesignStation entry in your Windows Start Menu, or by double-clicking the Launch PVC DesignStation shortcut on your desktop.

Windows Start Menu

The PanelView Component DesignStation installer creates an entry in the Windows Start Menu that can be used to launch the software. The shortcut is installed for all users.



Using PanelView Component DesignStation

PanelView Component DesignStation lets you create applications without being connected to a terminal.

- TIP** When using PanelView Component DesignStation 2.0 to create or change applications, make sure your pop-up blocker is off.
- TIP** For more information on working with PanelView Component DesignStation 2.0, refer to the context-sensitive help.

Firmware Update Utility

Chapter Objectives

This appendix shows how to use the PanelView Component Firmware Update Utility to perform recovery and maintenance operations on a PanelView Component terminal that is in a non-operating state.

IMPORTANT Use the utility described in this appendix only if the terminal is not operable.

TIP Always use the firmware upgrade described in Chapter 5 when you want to upgrade firmware to an operating terminal and functioning operating system.

About the Utility

The PanelView Component Firmware Update Utility is a PC application that interacts with the Boot Loader on the terminal via a USB connection to perform maintenance actions on the terminal firmware. The utility supports a firmware maintenance capability that is independent of the operating system and/or the other firmware elements on the terminal.

Use the utility only to recover from fatal conditions.

- A non-functioning operating system that resulted from a failed or interrupted firmware upgrade.
- A corrupted file system that blocks the operating system.
- A corrupted Windows registry that blocks the operating system.

The utility always requires a companion firmware image, SC XX-XX.IMG, even if you are only performing a Clean File System or Clean Registry operation.

Download the utility and the firmware image from:

<http://ab.rockwellautomation.com/Graphic-Terminals/2711C-PanelView-Component-Terminals>.

The utility lets you perform these operations separately or together:

- Update Firmware - installs a new or changed firmware image.
- Clean File System - formats the entire file system. All user-added content and user applications in the file system are erased including all changes to the Windows registry. The system reverts to a default registry. This operation also performs a clean registry operation since the registry is a file.
- Clean Registry - erases all changes to the Windows registry. The system reverts to a default registry. This operation removes registry settings, such as the user's selected startup application but does not remove user applications from the terminal.

The main dialog of the utility looks like this. You can perform maintenance operations separately or together by clicking the corresponding checkboxes. The screen shows all boxes checked.



The utility always requires a companion firmware image, SC XX-XX.IMG, even if you are only performing a clean file system or clean registry operation.

Download the utility and the firmware image from:

<http://ab.rockwellautomation.com/Graphic-Terminals/2711C-PanelView-Component-Terminals>.

The utility requires that you connect the USB host port of your computer to the USB device port on the terminal.

IMPORTANT

Before connecting your computer to the USB port of the PanelView Component terminal, you must first install the Allen-Bradley PanelView USB remote NDIS Network Device driver on your computer. [Refer to Install the USB Driver on page 65.](#)

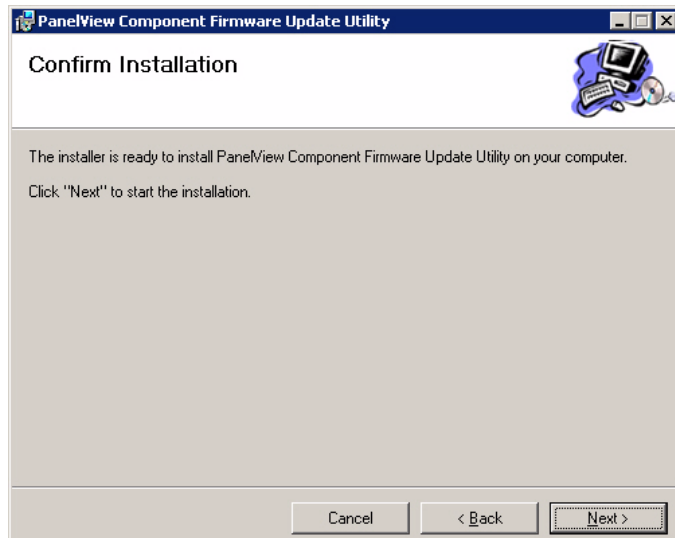

4. Click Next to start the installation.

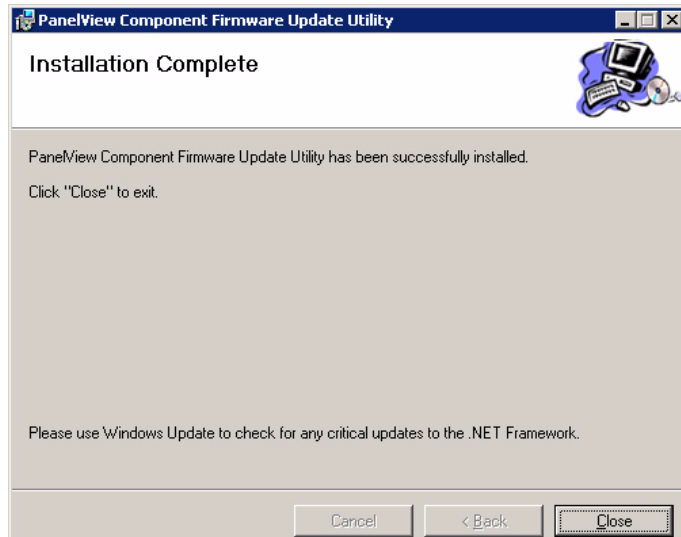

5. Click Close when the installation is complete.

Update Firmware

This section shows how to update the firmware image on a nonoperating terminal.

Follow these steps to update the firmware image on the terminal.

1. Connect the USB host port of your computer to the USB device port on the terminal.
2. From the Start Menu, select Programs>Allen-Bradley>PanelView Component Firmware Update Utility.

- When the utility is running, make sure Update Firmware is checked.

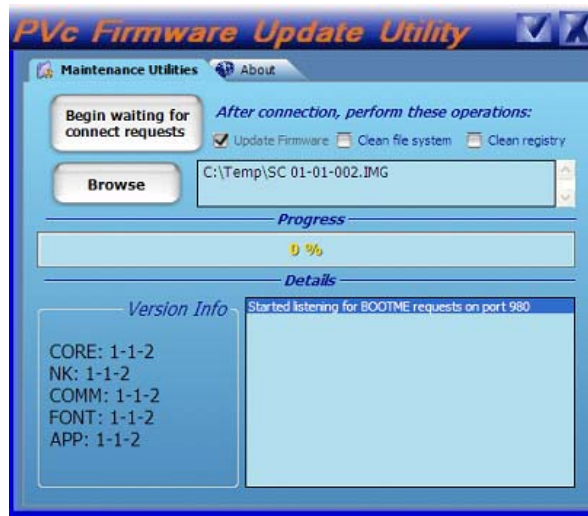

- Click the Browse Button to select an SC image, for example, SC 01-01-002.IMG.

The SC image is typically obtained from the PanelView Component technical support website.

When a valid SC image is opened, the version information is extracted and displayed.

- Click the Begin Waiting for Connect Requests button to start the firmware update.

The utility is waiting for an update request from the terminal.



- Reset the terminal.

TIP

Momentarily open the USB connection at the same time power is cycled. Otherwise, the power from the USB connection may prevent the terminal from resetting.

- Observe the progress bar and the Details window for status information as the images are downloaded to the terminal.



While the image is downloading, the terminal displays UPDATE 1E on its splash screen.

- Wait until you see the message on the progress bar that reads Image sent. Check Terminal for reboot completion.

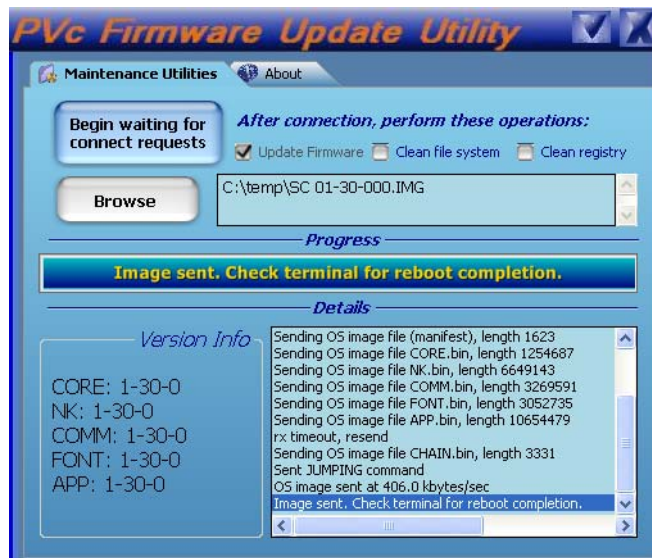

- Wait for the terminal to write the new image to flash memory.

During this operation, the terminal displays UPDATE A5 on the splash screen. After about one minute, the terminal displays Update Complete.

The terminal reboots itself when the new image is successfully written to flash memory.



ATTENTION: Please keep terminal powered on until it fully boots up.

10. Observe the firmware version information of the new image.

The firmware version is displayed on the startup screen and will also appear on the System Information screen when the terminal is in configuration mode.

Clean File System or Clean Registry

The procedure shows how to clean the file system and the registry. You can perform clean file system and clean registry operation separately or at the same time.

IMPORTANT Cleaning the file system removes all files, including user applications. Cleaning the registry only removes registry settings, such as the user's selected startup application but will not remove user applications from the terminal.

1. Connect the USB host port of your computer to the USB device port on the terminal.
2. From the Start Menu, select Programs>Allen-Bradley>PanelView Component Firmware Update Utility.
3. When the utility is running, make sure Clean File System, Clean Registry, or both are checked.

When you check Clean File System, Clean Registry is automatically checked because the registry is a file.

4. Click the Browse button to select an SC image, for example, SC 01-01-002.IMG.

The SC image is typically obtained from the PanelView Component technical support website.

When a valid SC image is opened, the version information is extracted and displayed.

- Click the Begin Waiting for Connect Requests button to send the selected operations to the terminal when requested.



The utility is waiting for an update request from the terminal.

- Reset the terminal.
 - TIP** Momentarily open the USB connection at the same time power is cycled. Otherwise, the power from the USB connection may prevent the terminal from resetting.
- Wait until you see the message on the progress bar that reads Image sent. Check Terminal for reboot completion.

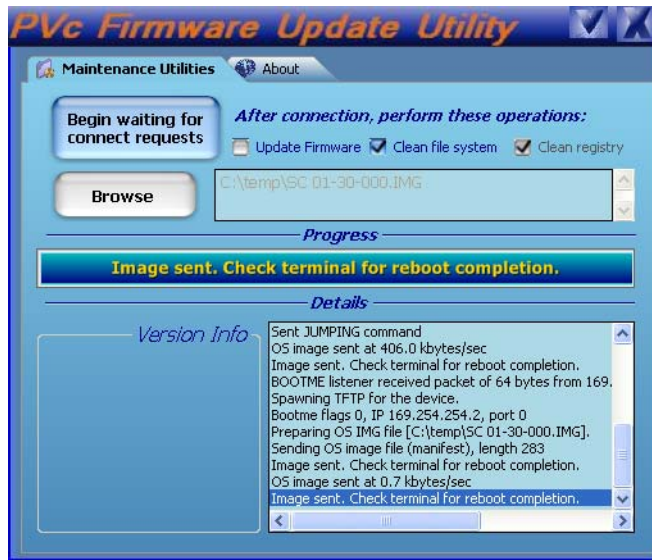

- The terminal reboots and automatically performs the requested operations during startup.

9. Check that the terminal reverts to the startup application.

Resolve Firmware Upgrade Issues

If you experience problems with the firmware update utility, check that your USB RNDIS adapter settings are correct.

1. Open the Windows Network Connections folder
2. Reset the Terminal.

TIP

Momentarily open the USB connection at the same time power is cycled. Otherwise, the power from the USB connection may prevent the terminal from resetting.

3. Right-click the connection with name Allen-Bradley PanelView Boot Loader USB Remote RNDIS Network Device when it appears, then select Properties. Note that this connection will disappear after a few seconds).

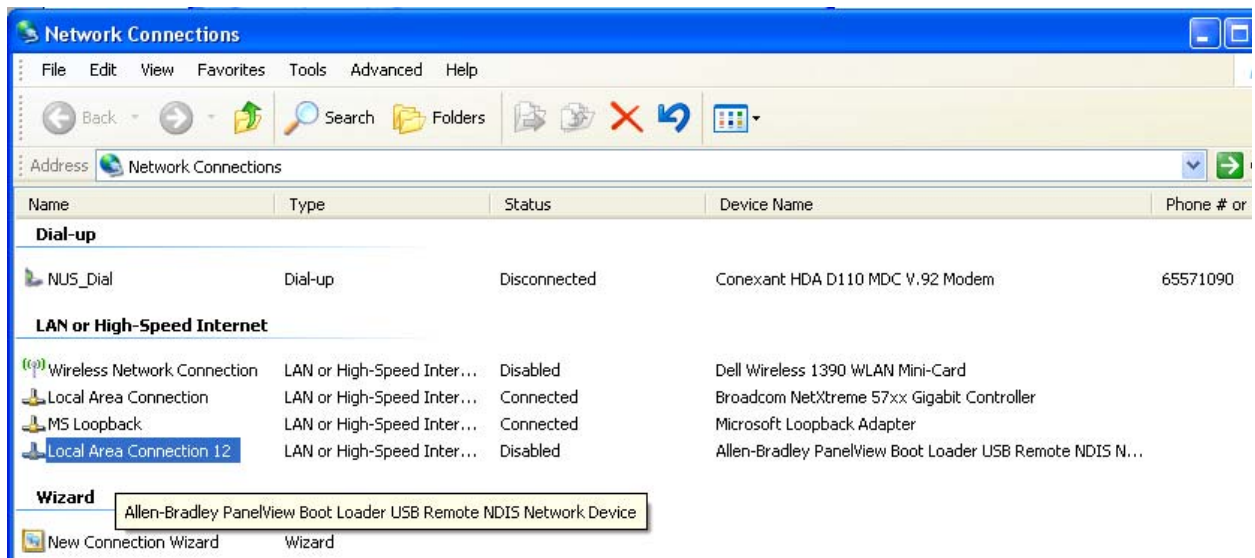

4. Select Advanced.

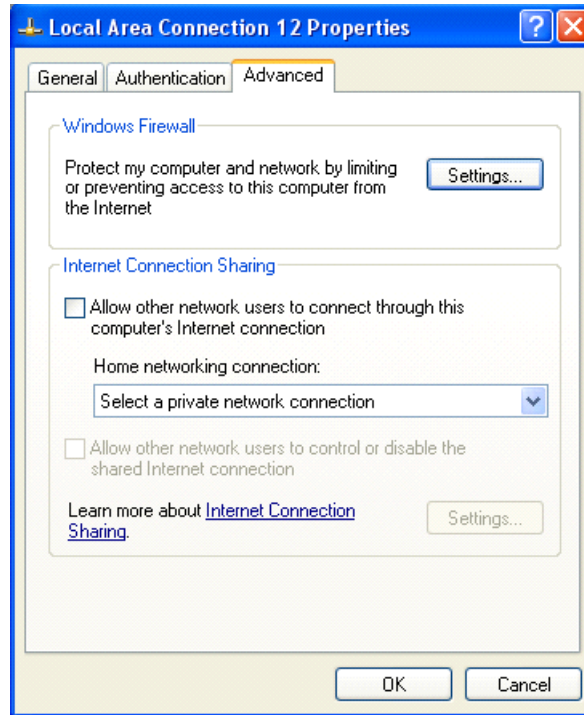

5. Select Windows Firewall Settings.

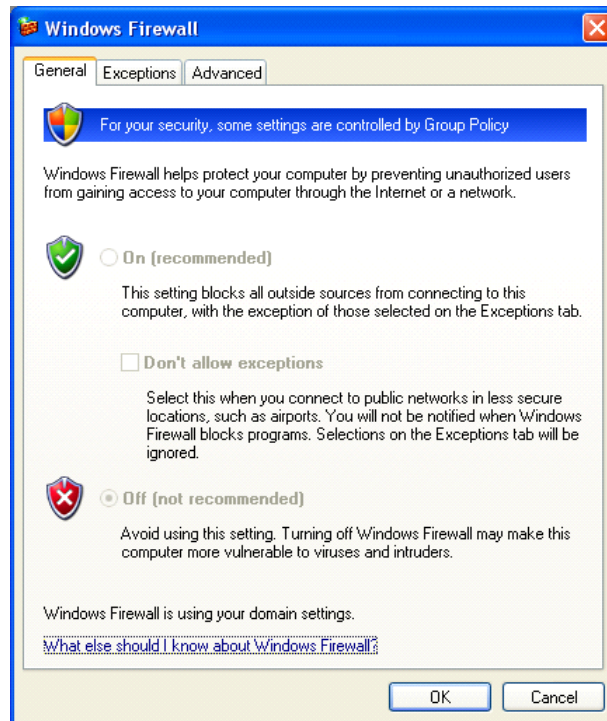

6. Check that the Windows Firewall is off. Click the OK button.

7. Click the General tab for connection properties.

8. Check that the Internet Protocol (TCP/IP) box is selected and no other protocols are selected.

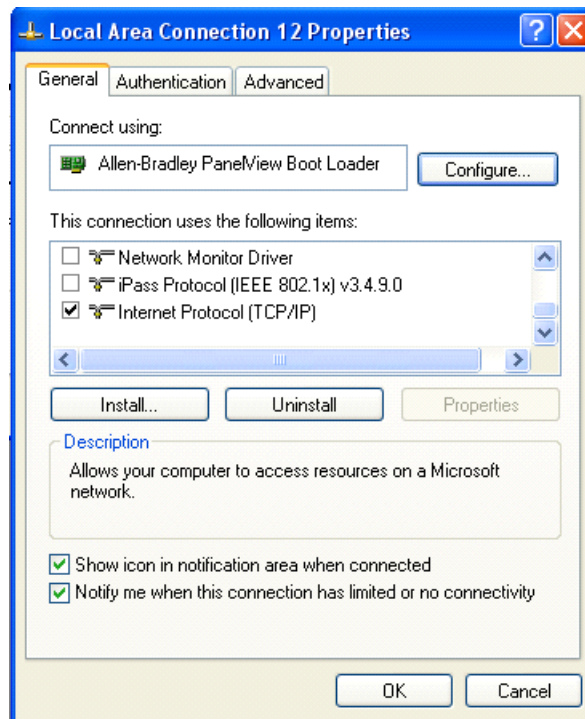

9. Select Internet Protocol (TCP/IP) and click the Properties button.
10. Check that the following IP address and Subnet Mask are set:
 - IP address: 169.254.254.1
 - Subnet mask: 255.255.0.0

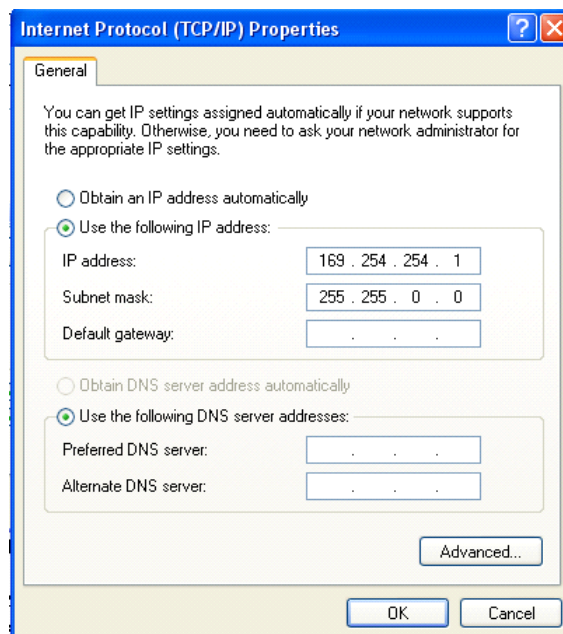

Software Maintenance

You can display the version information of the PanelView Component Firmware Update utility by clicking the About tab.

Use the Add or Remove Programs tool in the Control Panel of your computer to install a newer version or repair an existing installation of the PanelView Component Firmware Update utility.

Software Maintenance

You can display the version information of the PanelView Component Firmware Update utility by clicking the About tab.

Use the Add or Remove Programs tool in the Control Panel of your computer to install a newer version or repair an existing installation of the PanelView Component Firmware Update utility.

A

About PanelView Component DesignStation 2.0 119, 120

about the terminals 11

access configuration mode 17

adding fonts 99

additional resources 9

alerts 81

applications

- export 50
- import 51
- transfer 50

applications and files 49

available fonts 99

B

battery replacement

- C400 56
- C600 and C1000 57

brightness and contrast 25

- on terminal 26
- PanelView Explorer window 25

C

cables

- charts 60
- connections 59
- Ethernet 61

calibrate touch screen 31

- PanelView explorer window 32
- terminal 33

catalog number configuration 16

change startup application 36

- C200 and C300 38
- C600 and C1000 37
- PanelView explorer window 36

clean file system 135

clean registry 135

computer requirements 13

configuration interfaces 20

- PanelView explorer startup window 21
- terminal 20

configuration mode 17

- access 17
- design time 17
- runtime 19

connect a browser 13

- Ethernet 14
- USB ports 13

connect devices

60

D

date and time 39

- C400, C600 and C1000 40
- PanelView explorer window 39

design time 17

- operating systems 18
- supported browsers 18

DesignStation browser support 120

DesignStation directory layout and content 126

DesignStation installation requirements 121

DesignStation software installation 121

DesignStation software uninstallation 125

display help 14

E

emulator 103

- custom setup 105
- directory layout and content 112, 126
- emulator use 115
- error codes 117
- initial splash screen 104, 122
- install complete 106, 123
- installation 103, 121
- installation errors 108
- installation type 105, 123
- launch mechanism 114, 126
- launch windows start menu 115, 127
- license agreement 104, 122
- mapped share folder 114
- overview 103, 119
- progress screen 106
- uninstall 110
- uninstall extended support 107
- verify install 105

enable terminal security 44

Ethernet 14

- cables 61
- change settings 41
- connector 61
- PanelView explorer window 42
- security considerations 62
- settings C400, C600 and C1000 43

export applications 50

F

firmware

- install from storage device 78
- prepare for upgrade 75
- prepare storage device 78
- upgrade 75
- upgrades 10
- using removable storage device 76

fonts

- adding 99
- available 99
- import 99
- remove 100

H**how to**

- connect a browser 13
- display help 14

I**IGMP Protocol** 62**import applications** 51**import font** 99**install**

- battery 56
- SD memory card 55
- USB flash drive 55

install and replace components 55**intended audience** 9**Internet Group Management Protocol (IGMP)** 62**IP address of terminal** 13

- Ethernet port 14, 41
- USB port 13, 41

K**key repeat setting** 30**L****Launching DesignStation** 126**M****managing**

- applications 49
- files 49

MicroLogix cable charts 60**O****objectives** 9**operating systems** 18**out of box condition** 92**overview** 11**P****PanelView Component DesignStation 2.0**

119

PanelView component emulator 103**PanelView explorer window** 21

- brightness and contrast 25
- calibrate touch screen 32
- change startup application 36
- date and time 39
- Ethernet settings 42
- key repeat setting 30
- reboot terminal 34
- screen saver 27
- system information 47
- terminal security 44

peripheral connection 15**R****reboot terminal** 34

- C200 and C300 35
- C400, C600 and C1000 35
- PanelView explorer window 34

recovery operations 129**remove fonts** 100**replace screen saver image** 29**runtime** 19**S****screen saver** 27

- C200 and C300 28
- C400, C600 and C1000 28
- PanelView explorer window 27
- replace image 29

SD memory card 55**serial connections** 63

- RS422 and RS485 64

Simple Network Management Protocol (SNMP) 62**SNMP Protocol** 62**specifications** 95

- certifications 97
- environmental 97
- general 95

supported browsers 18

system information 47, 81
 C200 and C300 48
 C400, C600 and C1000 49
 PanelView explorer window 47

T

terminal

brightness and contrast 26
 calibrate touch screen 33
 change startup application C200 and C300 38
 change startup application C400, C600 and C1000 37
 date and time C400, C600 and C1000 40
 Ethernet settings C400, C600 and C1000 43
 interface 20
 language 24
 language C200 and C300 24
 language C400, C600 and C1000 24
 reboot terminal C200 and C300 35
 reboot terminal C400, C600 and C1000 35
 screen saver C200 and C300 28
 screen saver C400, C600 and C1000 28
 security 44
 security PanelView explorer window 44
 system information C200 and C300 48
 system information C400, C600 and C1000 49

terminal settings 22

brightness and contrast 25
 calibrate touch screen 31
 change startup application 36
 date and time 39
 enable terminal security 44

Ethernet 41
 key repeat 30
 on PanelView explorer startup window 23
 on terminal 22
 reboot terminal 34
 screen saver 27
 system information 47
 terminal language 24

transfer

applications 50
 user-defined objects 53

troubleshooting 81, 90

alerts 81
 check for power 90
 status indicators 91

U

Uninstall DesignStation 125

update firmware on nonoperating terminal 132

USB

device port 65
 flash drive 55
 host port 64
 install driver 65
 ports 13

user-defined objects 53

Using DesignStation 127

W

wiring and safety guidelines 59

Notes:



Rockwell Automation Support

Rockwell Automation provides technical information on the Web to assist you in using its products.

At <http://www.rockwellautomation.com/support/>, you can find technical manuals, a knowledge base of FAQs, technical and application notes, sample code and links to software service packs, and a MySupport feature that you can customize to make the best use of these tools.

For an additional level of technical phone support for installation, configuration, and troubleshooting, we offer TechConnect support programs. For more information, contact your local distributor or Rockwell Automation representative, or visit <http://www.rockwellautomation.com/support/>.

Installation Assistance

If you experience a problem within the first 24 hours of installation, review the information that is contained in this manual.

You can contact Customer Support for initial help in getting your product up and running.

United States or Canada	1.440.646.3434
Outside United States or Canada	Use the Worldwide Locator at http://www.rockwellautomation.com/support/americas/phone_en.html , or contact your local Rockwell Automation representative.

New Product Satisfaction Return

Rockwell Automation tests all of its products to ensure that they are fully operational when shipped from the manufacturing facility. However, if your product is not functioning and needs to be returned, follow these procedures.

United States	Contact your distributor. You must provide a Customer Support case number (call the phone number above to obtain one) to your distributor to complete the return process.
Outside United States	Please contact your local Rockwell Automation representative for the return procedure.

Documentation Feedback

Your comments will help us serve your documentation needs better. If you have any suggestions on how to improve this document, complete this form, publication [RA-DU002](#), available at <http://www.rockwellautomation.com/literature/>.

Rockwell Otomasyon Ticaret A.Ş., Kar Plaza İş Merkezi E Blok Kat:6 34752 İçerenköy, İstanbul, Tel: +90 (216) 5698400

www.rockwellautomation.com

Power, Control and Information Solutions Headquarters

Americas: Rockwell Automation, 1201 South Second Street, Milwaukee, WI 53204-2496 USA, Tel: (1) 414.382.2000, Fax: (1) 414.382.4444

Europe/Middle East/Africa: Rockwell Automation NV, Pegasus Park, De Kleetlaan 12a, 1831 Diegem, Belgium, Tel: (32) 2 663 0600, Fax: (32) 2 663 0640

Asia Pacific: Rockwell Automation, Level 14, Core F, Cyberport 3, 100 Cyberport Road, Hong Kong, Tel: (852) 2887 4788, Fax: (852) 2508 1846